

# U.S. Bellows

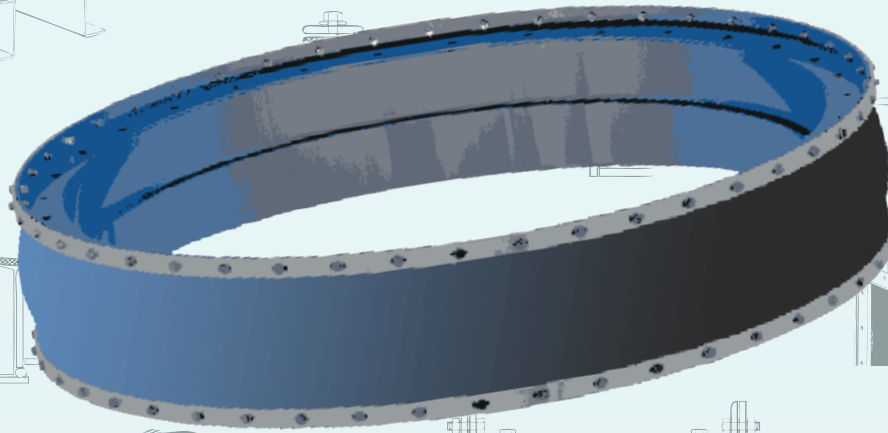

## Fabric Expansion Joint Catalog

1st Edition



*A Worldwide Leader in Expansion Joints*



Fabric Assembly Process



Assembling a 36" x 10" Face-to-Face Fabric Expansion Joint



Air Duct Fabric Expansion Joint



36" x 10" Face-to-Face Fabric Expansion Joint



U.S. Bellows Company Team Outside the Houston, TX Facility

**Local Phone:** +1-713-731-0030 | **Fax:** +1-713-731-8640 | **Toll Free:** 1-800-787-5914

**E-Mail:** [sales@usbellows.com](mailto:sales@usbellows.com) | **Website:** [www.usbellows.com](http://www.usbellows.com)





# TABLE OF CONTENTS

- Introduction..... 10
- What is a Fabric Expansion Joint..... 12
- Design Integration..... 13
- Fabric Expansion Joint Basics..... 14
- Fabric Expansion Joint Movement Chart..... 17
- Glossary of Fabric Expansion Joint Terms..... 18
- Fabric Expansion Joint Component Terms..... 19
- Specifying a Fabric Expansion Joint..... 20
- Fabric Expansion Joint Data Sheet..... 22
- Fabric Expansion Joint Applications..... 23
  - High Temperature Dirty Flue Gas..... 24
  - High Temperature Clean Air..... 26
  - Turbulent Air..... 28
  - Dirty Flue Gas..... 30
  - Turbulent Flue Gas, Wet Gas..... 32
  - Low Temperature Wet Flue Gas..... 34
- FLEXXCEL Fabric Expansion Joint Frame Designs**..... 36
- Frame Styles**..... 37
  - Weld-In Designs..... 37
  - Bolt In Designs..... 39
  - FLEXXCEL Expansion Joint Components..... 42
- FLEXXCEL Fluoroplastic Materials**..... 45
  - Evolution of FLEXXCEL Fluoroplastic Materials..... 47
  - FLEXXCEL Fluoroplastic Belt Materials..... 49
  - Guide to Selecting Fluoroplastic Belt Materials..... 50
  - FLEXXCEL Fluoroplastic Application Specific Materials..... 51



136" x 54" Fabric Expansion Joint for a Power System Company



Two 24" Diameter Fabric Expansion Joints for an Oil Refinery

# TABLE OF CONTENTS

**Fabric Expansion Joint Materials Comparison Chart**.....53

**FLEXXCEL Elastomeric Materials**.....54

    FLEXXCEL Elastomeric Belt Materials.....56

    Guide to Selecting an Elastomeric Belt Material.....57

**FLEXXCEL Fabric Expansion Joint Installation and Splicing Instructions**.....58

    Shipping and Installation of Fabric Expansion Joints.....59

    FLEXXCEL Installation Instructions.....60

    Assembled and Unassembled Frame Installation.....61

    Fluoroplastic Belt Splice.....62

    High Temperature Fluoroplastic Belt Splice.....63

    Installation Kits.....63

    EnsureAsplice Test Splice.....64

    Properly Installed External Insulation.....65

**Product Showcase**.....66

**Notes**.....96

**Terms of Sale**.....98



Fabric Expansion Joint for a Gas Turbine Power Plant



Multi-Layer High Temperature Rectangular Expansion Joints for a Gas Plant

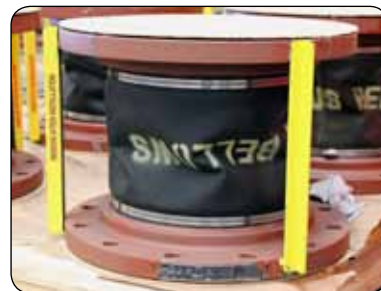

12" Diameter Fabric Expansion Joint Designed for a Lignite Coal Processing and Gasification Plant

## PRODUCT SHOWCASE INDEX

### Description

#### Single Expansion Joints

Single Flanged Expansion Joint for an Exhaust Duct.....	66
76" Diameter Single Expansion Joints with Refractory Lining.....	66
Same Day Turn Around Service: 8" Single Expansion Joint for an Emergency Shutdown.....	66
18" Single Expansion Joints for an Offshore Oil Platform in Korea.....	66
Single Tied Metallic Expansion Joints with Two-Ply Alloy Bellows.....	67
Flanged Expansion Joints for a Thermal Power Plant.....	67
18" Expansion Joints that Required Helium Leak Testing.....	67
5 Expansion Joints for a Heat Exchanger Company in Japan.....	67
Single Expansion Joint Assembly for an Oil Refinery in South Africa.....	68
188 Single Tied Expansion Joints for a Construction Company.....	68
14 Single Reinforced Metal Expansion Joints.....	68
4 Convolution Expansion Joints for an Oil Company in India.....	68
Single Tied Expansion Joints for an Oil Refinery.....	69
Immediate Refurbishment of a 3" O.A.L Single Bellows .....	69
Clamshell Bellows for a Shell and Tube Heat Exchanger.....	69
Three-day Emergency Fabrication of a 40" I.D. Expansion Joint.....	69
10" Single Tied Titanium Expansion Joints.....	70
Emergency Order for a 48" Diameter Expansion Joint.....	70
A Custom Spring Support Was Designed Using a Metal Bellows Instead of a Spring Coil.....	70
76" Diameter Single Tied Expansion Joint for a Hot Blast Valve in a Steel Mill.....	70
Single Expansion Joint for a Heat Exchanger.....	71
102" Diameter Tied Universal and Hinged Expansion Joints.....	71

#### Hinged Expansion Joints

66" Hinged Expansion Joint Designed for Gas Service.....	71
24" Universal Hinged Expansion Joint.....	71
Hinged and Universal Expansion Joints with Refractory Lining.....	72
48" Diameter Refractory Lined Expansion Joint for a Chemical Plant in Ecuador.....	72
92" Double Hinged Reinforced Expansion Joint for Water Service in Canada.....	72

#### Pressure Balanced Expansion Joints

24" Inline Pressure Balanced Expansion Joint.....	72
26" Diameter Pressure Balanced Elbow Expansion Joint.....	73
60" Diameter Universal Pressure Balanced Elbow Expansion Joints.....	73
8" Diameter Pressure Balanced Expansion Joint.....	73

## PRODUCT SHOWCASE INDEX

Elbow Pressure Balanced Expansion Joints for a Power Station in Canada.....	73
72" Universal Pressure Balanced Expansion Joint.....	74
<b>Refractory Lined Expansion Joints</b>	
30" Spent Catalyst Standpipe Metallic Expansion Joint with Pantographic Linkage.....	74
80" Refractory Lined Tied Universal Expansion Joint.....	74
60" Diameter Tied Refractory Lined Universal Expansion Joints.....	74
60" Diameter Double Hinged Refractory Lined Expansion Joint.....	75
55" O.D. Refractory Lined Universal Gimbal Expansion Joint.....	75
44" Universal Refractory Lined Expansion Joint.....	75
Universal Expansion Joint with 5" Thick Refractory Lining for a Styrene Plant in Thailand.....	75
Stainless Steel Expansion Joint for Catalytic Cracker Application.....	76
<b>Toroidal Expansion Joints</b>	
92" I.D. Toroidal Bellow Expansion Joint for an ASME "U" Stamp Heat Exchanger Shell.....	76
<b>Thick-Wall Expansion Joints</b>	
48" Diameter Thick-Wall Expansion Joint for a Refinery.....	76
5' x 22' Thick-Wall Tied Universal Expansion Joint.....	76
72" Diameter Thick-Wall Expansion Joint.....	77
12' Diameter Thick-Wall Duct Expansion Joint.....	77
Thick-Wall Expansion Joints for Texas Refinery.....	77
Thick-Wall Expansion Joint.....	77
72" Diameter Tied Universal Expansion Joint for a Sulfuric Acid Plant.....	78
<b>Fabric Expansion Joints</b>	
Rectangular Fabric Expansion Joint.....	78
36" x 10" Face-to-Face Fabric Expansion Joints.....	78
60" Ductwork and a Fabric Expansion Joint.....	78
3 Fabric Expansion Joints for a Power Company in Texas.....	79



128" x 229" Rectangular Fabric Expansion Joints

## PRODUCT SHOWCASE INDEX

17 Fabric Expansion Joints for a Gas Turbine Power Plant.....	79
48 Multi-Layer High Temperature Rectangular Fabric Expansion Joints.....	79
54" x 136" Fabric Expansion Joints for a Power System Company in Texas.....	79
Fabric Expansion Joints for a Power System Company in Texas.....	80
78" x 39" Rectangular Fabric Expansion Joint.....	80
5" x 12" Fabric Expansion Joint.....	80
Rectangular Fabric Expansion Joint for a Coal Fired Power Plant.....	80
87 Fabric Expansion Joints for a Furnace Application.....	81
Fabric Expansion Joints Up to 32' x 12'.....	81
12' x 30' x 12" High Temperature Fabric Expansion Joint.....	81
Fabric Expansion Joint for Duct System.....	81
Replacement Fabric Expansion Joint for a Methanol Plant.....	82
High-Temp Fabric Expansion Joints.....	82
Neoprene Fabric Expansion Joints for a Ventilation Fan Intake Duct.....	82
Fabric Expansion Joints Designed for a Lignite Coal Processing & Gasification Plant.....	82
81" Long Rectangular Fabric Expansion Joint for an Offshore Oil Extraction and Natural Gas Project.....	83
Rectangular Fabric Expansion Joint For High Air Circulation Flow.....	83
High Temperature Fabric Expansion Joint Designed for an Exhaust Duct.....	83
42" Diameter Neoprene Fabric Expansion Joint for a Generator Cooling Fan in a Power Plant.....	84
78" Fabric Expansion Joint and Duct Work Assembly with a 90° Elbow for a Sulphuric Acid Plant.....	84
Fabric Expansion Joint Designed for a Power Generator Unit.....	84
10' Square Fabric Expansion Joints.....	84
Air Duct Fabric Expansion Joint.....	85
44" Expansion Joints for a Petrochemical Plant.....	85
128" x 229" Rectangular Fabric Expansion Joints.....	85
Two Fabric Expansion Joints for an Oil Refinery in Saudi Arabia.....	86



Back Up Rings Installed on Round Fabric Expansion Joints



## PRODUCT SHOWCASE INDEX

### Rectangular Metallic Expansion Joints

84" Long Rectangular Metallic Expansion Joint.....	86
Tandem Rectangular Expansion Joint for Turbine Exhaust.....	86
55' Long x 14'-6" Rectangular Metal Expansion Joint.....	86
57" x 96" Rectangular Seal Expansion Joints.....	87
Three 12' x 8' Rectangular Expansion Joints with Full Radius Corners.....	87
28" x 66" Rectangular Expansion Joint.....	87

### Universal Expansion Joints

48" Tied Universal Expansion Joint with Two-Ply Bellows.....	87
Tied Universal Expansion Joint with a 45 Degree Mitered Elbow.....	88
66" Diameter Tied Universal Expansion Joint.....	88
15' Tied Universal Expansion Joint with Slotted Hinges.....	88
Metallic Universal Expansion Joint for an Emergency Shut Down.....	88
Expansion Joints for an Engineering and Construction Company.....	89
5,165 lb. Tied Universal Expansion Joint.....	89
48" Diameter Tied Universal Expansion Joints.....	89
3,212 lb. Tied Universal Joint for an Oil Piping System.....	89
6" Diameter Tied Universal Expansion Joints.....	90
Three 23' – 1/3" Expansion Joints for a Refinery in New Jersey.....	90
Expansion Joint Exhaust Assembly for an Oil Refinery in Texas.....	90
Tied Universal Expansion Joints for a Chemical Plant.....	90
14" Diameter Tied Universal Expansion Joints.....	91
54" Diameter Tied Universal Expansion Joint.....	91
28" and 32" Tied Universal Expansion Joints.....	91



Fabric Belt Assembly



Neoprene Fabric Expansion Joint



## PRODUCT SHOWCASE INDEX

Elbow Tied Universal Expansion Joints.....	91
47 ¼" I.D. Universal Expansion Joint.....	92
3" NPS Tied Universal Bellows for a Power Plant.....	92
Universal Tied Expansion Joint, 48" Dia. and 141" O.A.L., for Service in an Acid Regeneration Plant.....	92
42" Diameter Stainless Steel Expansion Joints for an Offshore Application.....	92
12" Diameter Universal Expansion Joints with Stainless Steel Bellows.....	93
Tied Universal Expansion Joints Designed for a Power Generation Plant in Texas.....	93
<b>Gimbal Expansion Joints</b>	
55" O.D. Universal Gimbal Expansion Joint with Floating Rings.....	93
192" Double Gimbal Expansion Joints.....	93
36" Expansion Joints for a Company in Singapore.....	94
<b>Externally Pressurized Expansion Joints</b>	
Specially Designed Expansion Joints with 13" of Movement.....	94
56 Externally Pressurized Expansion Joints for a Cooling System.....	94
<b>Rubber Expansion Joints</b>	
59" Neoprene Expansion Joint.....	94
Two Expansion Joints for an Air Intake on a Generator Unit.....	95
42" I.D. Rubber Expansion Joints.....	95
EPDM Tied Expansion Joints for a Construction Company.....	95
Double Arched PTFE-lined Rubber Expansion Joints for a Polysilicon Plant.....	95

View our online catalog at: [www.usbellows.com/fabric-catalog](http://www.usbellows.com/fabric-catalog)



44" Expansion Joints for a Petrochemical Plant

## INTRODUCTION

U.S. Bellows has designed and manufactured a variety of expansion joints for many years including metallic and fabric expansion joints.

This catalog is devoted to fabric expansion joints. It includes fabric expansion joint basics, movement charts, applications, frame designs, and more.

In addition to manufacturing expansion joints, U.S. Bellows can design complete assemblies to meet your specific needs. We will also build and test prototypes prior to final production. We have the latest computer software to speed the design process when standard products do not meet your specific requirements.

In many cases you are simply replacing an existing joint which has performed over its expected life. We may suggest that you consider alternatives, which based on our experience, would be cost-effective. Our production and inventory systems will support timely manufacture of replacements at a competitive price.

The parameters which govern the specification of an expansion joint include the temperatures and pressures of the materials flowing in the system (solids, liquids, gases and combinations of these), the mechanical linkage to the system where they are installed, and the movement and forces the system will exert on the expansion joint. Each section of this catalog provides information about the parameters to be selected to order the expansion joint you require.

## Facilities

In 1995 we added a new 101,000 square foot building to our manufacturing facility. The expansion joint equipment obtained from RM Engineered Products is located in the Southeast part of this building. A new crane way has been installed in this area 21 feet above the floor. Structural components for fabric expansion joints are fabricated in the U.S. Bellows area. Special sewing machines are used to produce the fabric components required.



*From L to R: Randy Bailey, Vice President;  
Dr. Durga D. Agrawal, President; and John Demusz,  
U.S. Bellows Manager*

In December of 2011, U.S. Bellows acquired all bellows assets of the former Lortz Manufacturing company. This acquisition included the fabrication equipment, expansion joint and bellows drawings, design software, customer lists, and all engineering history and other historical data associated with Lortz Manufacturing.

## AERIAL VIEW



U.S. Bellows, along with its parent company Piping Technology & Products, Inc. and fellow subsidiaries, share engineering and manufacturing resources at our 35-acre manufacturing facility in Houston, Texas. U.S. Bellows' manufacturing facilities are located near the Port of Houston, the largest port in the United States, for fast and convenient shipping around the world. We have 450,000 square feet of covered shop space at our manufacturing facility in Houston.

U.S. Bellows extends an invitation to all its customers to come to Houston and visit the plant. This is the best way to see our people, our facilities, and the many capabilities we have to serve you.



Elbow Pressure Balanced Expansion Joints being Manufactured in our U.S. Bellows Facility



## WHAT IS A FABRIC EXPANSION JOINT?

Fabric expansion joints perform a function of compensating for duct misalignment and duct thermal growth typical in power plants and other ducting systems. Fabric expansion joints are found wherever there is a need to convey hot media in low pressure applications such as “in flowing air” and “out flowing gas” in large combustion processes.

Fabric expansion joints can absorb larger movements than metal expansion joints and do so without spring loads. This is critical to limiting thermally induced stresses in ducting, ducting supports, and related equipment.

## How Does a Fabric Expansion Joint Work?

A fabric expansion joint is inserted into a gap in the duct work where movement will occur. A fabric expansion joint has two main components -- the fabric gas seal and the metal frames. The fabric gas seal is a closed loop, like a belt, with its two edges clamped all around to the metal frames that are in turn connected to the end of ducting. As the ducting moves, the fabric belt deforms. The fabric material must do this without tearing or leaking while sometimes being exposed to high temperatures and/or corrosive media.

In some instances, additional components such as insulation pillows, accumulation barriers or flow liners are utilized to help protect the fabric material. The following section describes the basics of fabric expansion joint components and how they are designed.

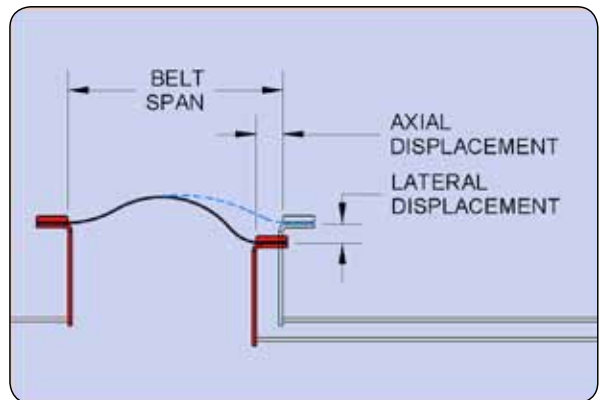
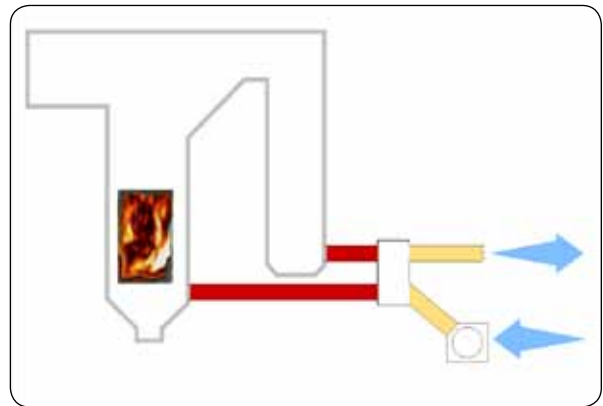

Neoprene Fabric Expansion Joints

## DESIGN INTEGRATION FOR FABRIC EXPANSION JOINTS

In addition to fabric expansion joints, U.S. Bellows is a major designer and fabricator of ducting and piping. DESIGN INTEGRATION is the design, manufacture



and shipping of expansion joints integrated into the ducting as a complete unit directly from U.S. Bellows. This enables U.S. Bellows to offer optimum system design at the lowest installed cost.



78" Fabric Expansion Joint and Duct Work Assembly with a 90° Elbow for a Sulphuric Acid Plant

### Design Integration Advantages:

- Minimize the number of flanged expansion joint connections.
- Allows integration of ducting to serve as expansion joint flow liner.
- Allows expansion joint frames to take the place of duct stiffeners.
- Elimination of labor to install flanged expansion joint assemblies at the job site.

- Elimination of flanged connection gasketing and potential leaks.
- Elimination of the risk of installing sensitive assemblies at the job site.
- Significant costs savings of both manufacturing and installation labor.
- Delivery of the largest “shippable” duct and piping sections to the job site to eliminate as many field connections as possible, further reducing installation labor.

U.S. Bellows has considerable experience in design and fabrication of integrated ducting and piping with metal and fabric expansion joints. U.S. Bellows is also very knowledgeable with transportation capabilities for wide and heavy loads and can make firm commitments “up-front” for the largest shippable size and heaviest weight.

The drawing below shows a cross section of an expansion joint designed to allow the ducting to serve as a flow liner. The joint frame takes the place of a stiffener flange. The complete duct/expansion joint ships as one factory assembled component.

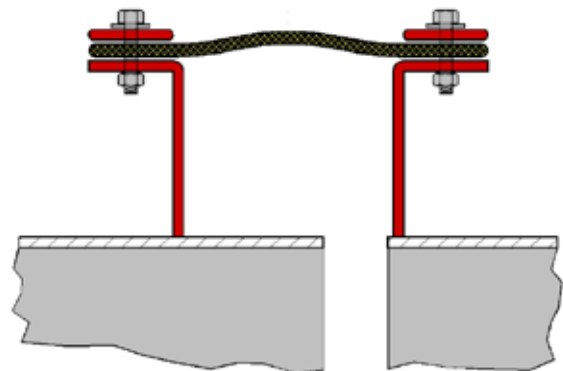

## FABRIC EXPANSION JOINT BASICS

### Fabric Expansion Joints and Factors Influencing their Design

Fabric expansion joints perform a function of compensating for duct misalignment and duct thermal growth typical in power plants and other ducting systems. Proper design of these joints starts with asking the right questions about the application, providing the correct answers, and applying design rules to arrive at the appropriate solution.

The guiding principle for fabric joint design is to protect the fabric belt element so that it can absorb movement while retaining the media. The longevity of the belt life can be diminished by many factors. These factors include excessive temperature, harsh corrosives, exposure to abrasive particulate, excessive movements, fly ash weight against the belt, and high internal pressures. All of these problems can be solved if they are anticipated. The quality of the expansion joint design is only as good as the information provided up front. A realistic and accurate analysis of the system is step one. Assuming that is taken care of, these guidelines are a brief introduction to factors that influence the success of the expansion joint.

#### Temperature

Fabric gas seal membranes have specific temperature capabilities. When necessary, the addition of insulating materials between the temperature source and the belt will extend the service life. The magnitude of the temperature will determine the thickness of the

integral belt insulation and if a separate high density insulation pillow is required. The belt attachment flanges should be outboard of the cavity and have sufficient standoff from the duct. Care should be taken to avoid external insulation or lagging outside of the belt which prevents proper heat dissipation.

#### Chemical Attack

Applications that do not have high temperatures sometimes have a different problem. Relatively low temperatures in flue gas ducting can lead to corrosive condensation. In these situations, a chemical barrier is required to protect the load bearing fiberglass carcass of the belt. External insulation over the joint in these locations can reduce condensation and heat loss.

#### Movements

Generally, movements occur along the axis of the duct (usually compression but occasionally extension) or at right angles (lateral). The key to being able to handle these movements is having the proper width of belt installed in a sufficient span. For compression, a ratio of installed belt span to movement roughly at 4:1 is suggested. The lateral capability is influenced by the amount of belt slack available. Concurrent axial compression will provide the slack thus allowing more lateral. In certain situations, there is lateral offset in the cold installed condition. This may require “pre-compression” of the joint which is in essence just providing extra belt width.



## Abrasion

In flue gas ducting with particulate, a liner should be used to protect the belt from direct exposure. If the pressure is negative, the belt stand-off from the gas stream should be increased to keep the belt from being pulled into the gas stream or against the liner. Belt clamping bar edges next to the fabric should be radiused. The belt attachment flange should also be smooth and free of rough surfaces.

## Pressure Fluctuations

Fabric expansion joints exposed to sudden pressure fluctuations, such as near ID fans and dampers, may result in the belt “fluttering”. The fabric will fatigue over time resulting in tears. Using stiffer fabric material, installing a liner and increasing the standoff are steps to take to avoid flutter.

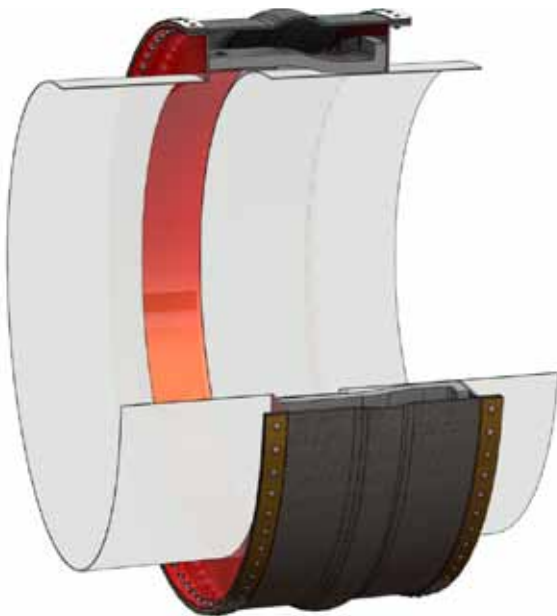

## Summation

Each location throughout a ducting system can have different conditions that affect the design of expansion joints. As a result, there isn't one design that can fit all applications. The goal of the expansion joint supplier is to work with engineers and end users to provide the optimum economical solution.



108" Diameter Fabric Expansion Joints



42" Diameter Neoprene Fabric Expansion Joint for a Generate Cooling Fan in a Power Plant

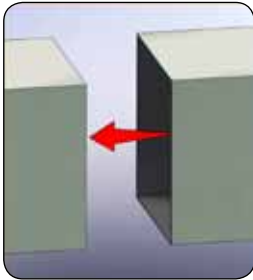

### **Axial Compression**

The reduction in the breach opening along the axis of the duct. This is usually a result of thermal expansion of the ducting.

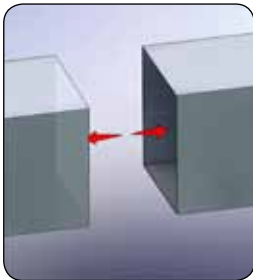

### **Axial Extension**

The increase in the breach opening along the axis of the duct. In certain configurations, the duct thermal expansion may result in extension at the expansion joint location.

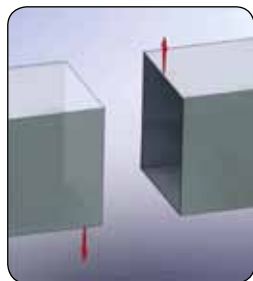

### **Lateral Movement**

The relative movement of the upstream and downstream faces in the direction perpendicular to the axis of the duct.

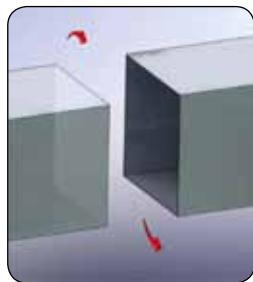

### **Torsional Rotation**

The twisting of one side of the duct about the longitudinal axis.

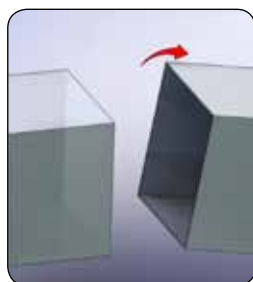

### **Angular Rotation**

The twisting of one side of the duct about an axis perpendicular to the longitudinal axis.

## FABRIC EXPANSION JOINT MOVEMENT CHART

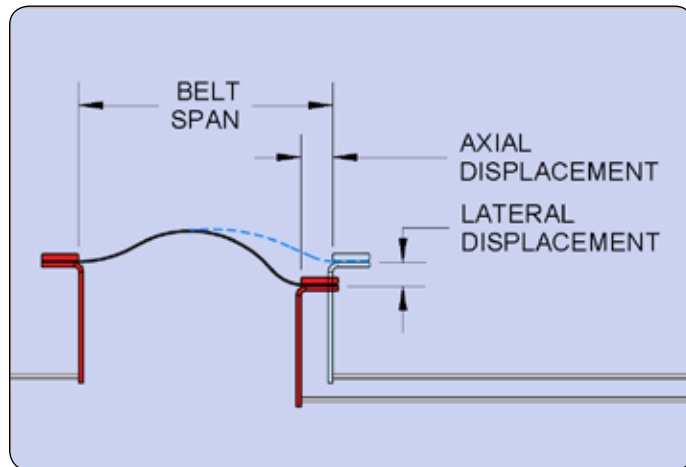
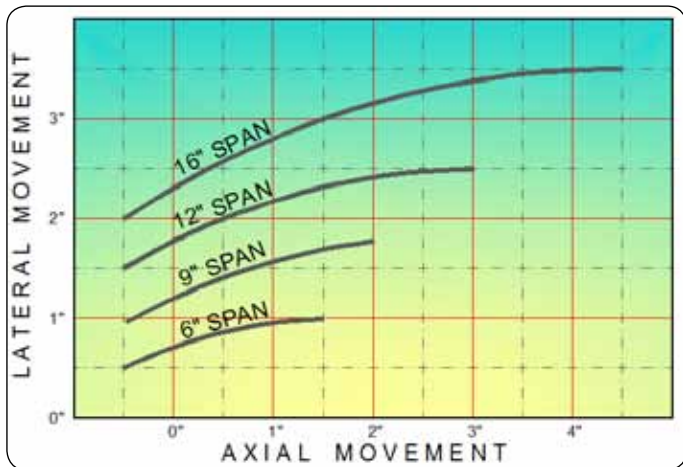

The chart shown above depicts the relationship of belt span, maximum compression and concurrent lateral movements. The maximum compression is a percentage of the available belt span (shown at the right end of the plot line). The wider the span, the more capacity for compression. The lateral capacity is a function of the belt slack created with concurrent compression.

As the compression increases, more belt material is available to safely allow movement without overstressing the fabric material. In situations with large lateral movement and little compression, the joint can be installed pre-compressed to have more lateral capacity.

When in doubt, allow experienced U.S. Bellows engineers to help select the correct span for each particular application.



81" L x 18" W x 16" Face-to-Face Rectangular Expansion Joint Designed for High Air Circulation Flow for an Air Cooling Loop Duct in a Power Plant



Rectangular Fabric Expansion Joint Measuring 13" L x 54" W x 12" Face-to-Face for an Exhaust Duct in a Power Plant



## GLOSSARY OF FABRIC EXPANSION JOINT TERMS

**Cold Shell:** A duct that is internally insulated with refractory material.

**Fabric Expansion Joint:** An assembly that utilizes a fabric belt element to allow for the movement of ductwork, as opposed to a metal expansion joint which allows for the movement by means of convoluted metal bellows.

**Fabric Over Metal:** A design that allows for a fabric expansion joint to be installed over a metal expansion joint.

**Flutter:** The phenomenon that can occur in the fabric material due to turbulence of the gas flow. Flutter can occur in locations where pressure fluctuation occurs such as near dampers and fans. Intense flexing of the fabric could lead to premature failure, thus the use of liners, fillers, or heavier fabric is recommended.

**Heat Seal Splice:** For Fluoroplastic material, a process of splicing or repairing the fabric material with means of a special iron and a film of PTFE sheet.

**Hot Shell:** A duct that is externally insulated.

**Inboard Flange:** A design where the inside of the belt attachment flange is not accessible from outside the expansion joint.

**Inside Replaceable:** The expansion joint design that allows the belt to be installed and replaced from inside the duct.

**Mating Flange:** A structural angle or channel that is welded to the end of the ducting to facilitate bolting or welding the expansion joint into the system.

**Outboard Flange:** A design where both sides of the belt attachment flange are accessible from the outside of the expansion joint.

**Vulcanize:** A process of heating and adding sulfur to an elastomeric material. Vulcanizing is required in the manufacturing and splicing of elastomers.

### Dimensional Terms

**Breach:** The opening in the duct where the expansion joint is installed.

**Face-to-Face:** See Span.

**ID:** Inside Duct Dimension.

**OD:** Outside Duct Dimension.

**Setback:** See Standoff.

**Span:** Working opening between inside edges of backup bars.

**Standoff:** The distance of the fabric belt from the gas stream. The proper standoff allows belt cooling in high temperature applications and prevents the belt from being pulled into the gas stream in negative pressure.

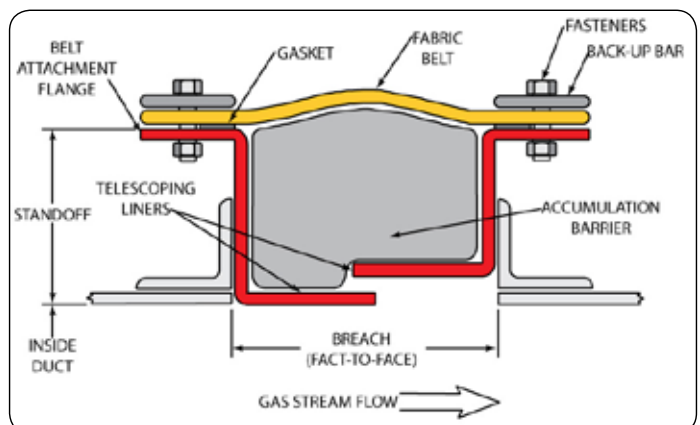

## FABRIC EXPANSION JOINT COMPONENT TERMS

**Accumulation Barrier:** In applications where fly ash is present in the gas stream, a barrier is installed in the cavity of the expansion joint. The barrier is constructed of low density insulation wrapped in fiberglass cloth. The accumulation barrier helps prevent the particulate from building up in the cavity along the bottom of a joint in horizontal ducting.

**Back-Up Bars:** Metal bars with fastener holes used for clamping along the edges of the fabric gas seal to the belt attachment flange.

**Baffle:** See Liner.

**Belt Attachment Flange:** The face of the expansion joint where the belt is clamped using a back-up bar. The flange can be turned out (see Outboard Flange) or turned in (see Inboard Flange). Either way, many designs allow for the belt attachment flange to be offset from the duct (see Standoff).

**Clamp Bars:** See Back-Up bars.

**Fabric Belt:** The flexible non-porous element of a fabric expansion joint. The fabric belt must be able to withstand the thermal pressure and chemical conditions. Modern fabrics accomplish this with a chemically inert barrier bonded to high strength substrate. For high temperature applications, a layer of insulation is incorporated into the belt.

**Gasket:** A non-porous deformable material that is installed between the belt attachment flange and the fabric belt. The gasket allows a gas tight seal when the back-up bar clamping action is applied.

**Insulation Pillow:** In applications where the gas stream temperature is greater than the fabric belt

alone can withstand, an insulation pillow can be installed, usually by pinning to telescoping liners. An insulation pillow is constructed of high density material wrapped in cloth with wire mesh reinforcement.

**Insulation Tape:** A thin layer of insulating material, usually woven fiberglass, that is installed between the belt attachment flange and the fabric belt. In certain cases, insulation tape is also used between the fabric belt and the back-up bar. The purpose of the tape is to prevent the conduction of high temperatures to the fabric material where it is clamped.

**Liner:** The liner is metal plate or plates that are designed to protect the fabric belt from the gas stream while at the same time allowing the expansion joint movement. The liner can be bolted, welded, floating, or integral to the standoff frame. A single liner is connected to the upstream side of the expansion joint. In some cases, a second “telescoping” liner is used on the downstream side.

**Radius Corner:** The belt radius at the corner of rectangular expansion joints. The radius corner helps prevent sharp creases that may shorten belt life.



13' x 5' Fabric Expansion Joint Fabricated with PTFE Impregnated Fiberglass

## SPECIFYING A FABRIC EXPANSION JOINT

Use this section as a guide for specifying the most cost effective frame and fabric belt design. A fossil fired power plant is used to illustrate a range of conditions that can be found in many industrial applications. They range from ambient air to high temperature fly ash laden flue gas. By choosing the area of the plant that best matches your application, it is possible to see several solutions ranked in order of performance and cost.

The rankings of the expansion joint designs are weighted more by performance than initial cost. In real world applications, the access to fabric expansion joints for repair or replacement can be problematic. *The cost to replace inadequate fabric expansion joints greatly exceeds the initial cost of a higher performing design and material.*

*\*\*This FLEXXCEL Design Manual was not intended to cover all fabric expansion joint designs. Please contact U.S. Bellows for other expansion joint design solutions.*

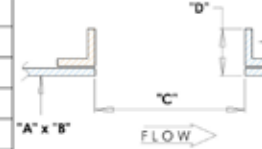
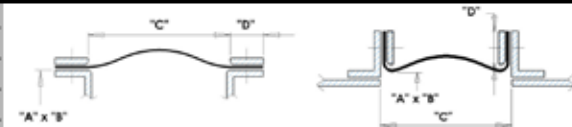
Fabric Expansion Joint Data Sheet						
Customer		Address		Contact		
Phone		Fax		Email		
Type of Plant		Location		Date		
Item/Tag		Quantity				
<input type="checkbox"/> New Expansion Joint		<input type="checkbox"/> Replacement Expansion Joint		<input type="checkbox"/> Replacement Fabric Only		
Duct Information	"A" (One Side or Diameter)			<input type="checkbox"/> Bolt Attachment? Provide details Notes		
	"B" (Other Side)					
	"C" (Breach Opening)					
	"D" (Flange if Applicable)					
	Duct Thickness					
Duct Material						
Application	Operating	Design	Excursion	Duration (min)		
	Temperature (F)					
	Pressure (inch H2O)					
	Movements	Compression	Extension	Lateral	Other	
	Media :	<input type="checkbox"/> Air (clean) <input type="checkbox"/> Flue Gas <input type="checkbox"/> Dirty Flue Gas <input type="checkbox"/> Wet Flue Gas <input type="checkbox"/> Other				
Flow Direction		Flow Velocity (Ft/Sec)				
Fabric Belt Material (If Known)						
Expansion Joint Style / Options	<input type="checkbox"/> Style 100B		<input type="checkbox"/> Style 100W		<input type="checkbox"/> Style 200B	
	<input type="checkbox"/> Style 200W		<input type="checkbox"/> Style 300B		<input type="checkbox"/> Style 300W	
	<input type="checkbox"/> Style 400B		<input type="checkbox"/> Style 500B		<input type="checkbox"/> Style 600B	
	<input type="checkbox"/> Style 600W		<input type="checkbox"/> Style 700B		<input type="checkbox"/> Style 700W	
	Options		<input type="checkbox"/> Accumulation Pillow		<input type="checkbox"/> Heat Seal Iron Kit (Rental)	
			<input type="checkbox"/> Liner (Bolt on)		<input type="checkbox"/> Heat Seal Iron Kit (Purchase)	
			<input type="checkbox"/> Liner (Field Weld)		<input type="checkbox"/> Drain	
			Other			
	<input type="checkbox"/> Fully Assembled		<input type="checkbox"/> Unassembled, Field Welds, Fabric Splice and Drill			
	<input type="checkbox"/> Assembled in C-sections, (2) Field Welds, Fabric Splices Req'd.		<input type="checkbox"/> Fabric Belt Only (See Section Below)			
Fabric Only	"A" Inside Belt Dim. (One Side or Dia.)					
	"B" Inside Belt Dim. (Other Side)					
	"C" Width Between Clamp Bars					
	"D" Width of Clamp Bars					
	Overall Belt Width					
	Corner Radius (Rect. Only)					
		<input type="checkbox"/> Factory Splice <input type="checkbox"/> Field Splice <input type="checkbox"/> Factory Holes <input type="checkbox"/> Field Holes				



Contact Information

Fabric Expansion Joint Data Sheet					
Customer		Address		Contact	
Phone	Fax		Email	Date	
Type of Plant		Location		Item/Tag	Quantity
<input type="checkbox"/> New Expansion Joint		<input type="checkbox"/> Replacement Expansion Joint		<input type="checkbox"/> Replacement Fabric Only	

Provide contact information, type of plant, tag numbers, quantity and scope of supply.

Dimensional Information

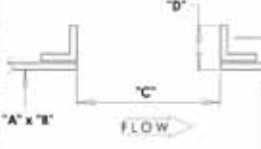
Duct Information	"A" (One Side or Diameter)		<input type="checkbox"/> Bolt Attachment? Provide details
	"B" (Other Side)		Notes
	"C" (Breach Opening)		
	"D" (Flange if Applicable)		
	Duct Thickness		
	Duct Material		









Provide duct dimensions, breach opening, and duct flange information if applicable.

Application Information

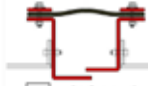
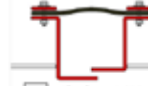
Application	Operating	Design	Excursion	Duration (min)		
	Temperature (F)					
	Pressure (inch H2O)					
	Movements		Compression	Extension	Lateral	Other
	Media : <input type="checkbox"/> Air (clean) <input type="checkbox"/> Flue Gas <input type="checkbox"/> Dirty Flue Gas <input type="checkbox"/> Wet Flue Gas <input type="checkbox"/> Other					
	Flow Direction		Flow Velocity (Ft.Sec)			
Fabric Belt Material (If Known)						

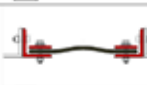
This information is key to selecting the appropriate expansion joint frame design and fabric material.

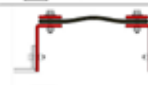
Expansion Joint Styles & Options

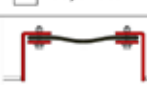
Expansion Joint Style / Options					
	<input type="checkbox"/> Style 100B	<input type="checkbox"/> Style 100W	<input type="checkbox"/> Style 200B	<input type="checkbox"/> Style 200W	<input type="checkbox"/> Style 300B
					
	<input type="checkbox"/> Style 300W	<input type="checkbox"/> Style 400B	<input type="checkbox"/> Style 500B	<input type="checkbox"/> Style 600B	<input type="checkbox"/> Style 600W
			<b>Options</b> <input type="checkbox"/> Accumulation Pillow <input type="checkbox"/> Heat Seal Iron Kit (Rental) <input type="checkbox"/> Liner (Bolt on) <input type="checkbox"/> Heat Seal Iron Kit (Purchase) <input type="checkbox"/> Liner (Field Weld) <input type="checkbox"/> Drain Other		
	<input type="checkbox"/> Style 700B	<input type="checkbox"/> Style 700W			
Frame Assy	<input type="checkbox"/> Fully Assembled		<input type="checkbox"/> Unassembled, Field Welds, Fabric Splice and Drill		
	<input type="checkbox"/> Assembled in C-sections, (2) Field Welds, Fabric Splices Req'd.		<input type="checkbox"/> Fabric Belt Only (See Section Below)		





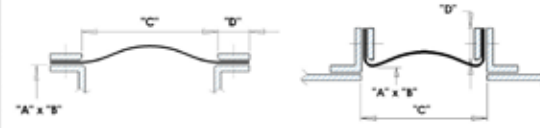

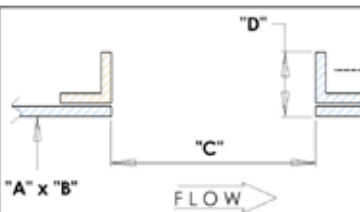
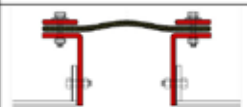

Based on the application information provided above, refer to "Recommended Expansion Joint Designs" in the following pages in order to narrow the selection process. Provide duct dimensions, breach opening, and duct flange information if applicable.

Fabric Only Information

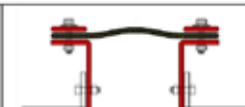
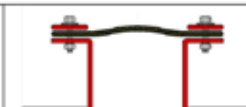
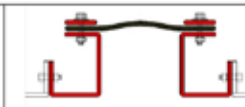
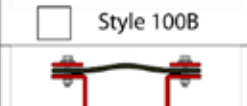
Fabric Only	"A" Inside Belt Dim. (One Side or Dia.)			
	"B" Inside Belt Dim. (Other Side)			
	"C" Width Between Clamp Bars			
	"D" Width of Clamp Bars			
	Overall Belt Width			
	Corner Radius (Rect. Only)			
	<input type="checkbox"/> Factory Splice	<input type="checkbox"/> Field Splice	<input type="checkbox"/> Factory Holes	<input type="checkbox"/> Field Holes

When expansion joint frames are provided by others, provide the dimensional data shown for proper fabric fit.

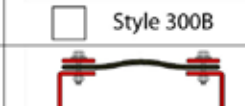
On the following pages, sample data sheets are shown for each set of conditions. This is intended to provide guidance with frame style and fabric belt selection. A blank sheet can be found on page 22. Please use the U.S. Bellows data sheet as a tool for communicating expansion joint inquiries.

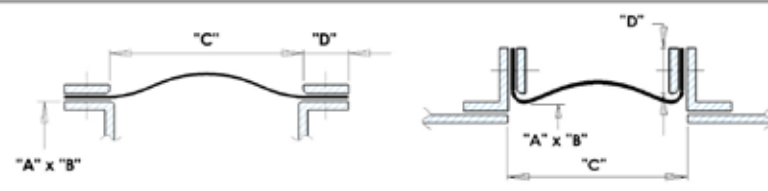
<b>Fabric Expansion Joint Data Sheet</b>						
Customer		Address		Contact		
Phone		Fax		Email		
Type of Plant		Location		Item/Tag		
				Quantity		
<input type="checkbox"/> New Expansion Joint		<input type="checkbox"/> Replacement Expansion Joint		<input type="checkbox"/> Replacement Fabric Only		
<b>Duct Information</b>	"A" (One Side or Diameter)			<input type="checkbox"/> Bolt Attachment? Provide details Notes		
	"B" (Other Side)					
	"C" (Breach Opening)					
	"D" (Flange if Applicable)					
	Duct Thickness					
	Duct Material					
<b>Application</b>	Operating	Design	Excursion	Duration (min)		
	Temperature (F)					
	Pressure (inch H2O)					
	Compression	Extension	Lateral	Other		
	Movements					
Media :	<input type="checkbox"/> Air (clean) <input type="checkbox"/> Flue Gas <input type="checkbox"/> Dirty Flue Gas <input type="checkbox"/> Wet Flue Gas   Other					
	Flow Direction		Flow Velocity (Ft.Sec)			
<b>Fabric Belt Material (If Known)</b>						
<b>Expansion Joint Style / Options</b>						
	<input type="checkbox"/> Style 100B	<input type="checkbox"/> Style 100W	<input type="checkbox"/> Style 200B	<input type="checkbox"/> Style 200W	<input type="checkbox"/> Style 300B	
						
	<input type="checkbox"/> Style 300W	<input type="checkbox"/> Style 400B	<input type="checkbox"/> Style 500B	<input type="checkbox"/> Style 600B	<input type="checkbox"/> Style 600W	
			<b>Options</b> <input type="checkbox"/> Accumulation Pillow <input type="checkbox"/> Heat Seal Iron Kit (Rental) <input type="checkbox"/> Liner (Bolt on) <input type="checkbox"/> Heat Seal Iron Kit (Purchase) <input type="checkbox"/> Liner (Field Weld) <input type="checkbox"/> Drain Other			
	<input type="checkbox"/> Style 700B	<input type="checkbox"/> Style 700W				
	<b>Frame Assy</b>	<input type="checkbox"/> Fully Assembled		<input type="checkbox"/> Unassembled, Field Welds, Fabric Splice and Drill		
		<input type="checkbox"/> Assembled in C-sections, (2) Field Welds, Fabric Splices Req'd.		<input type="checkbox"/> Fabric Belt Only (See Section Below)		
	<b>Fabric Only</b>	"A" Inside Belt Dim. (One Side or Dia.)				
"B" Inside Belt Dim. (Other Side)						
"C" Width Between Clamp Bars						
"D" Width of Clamp Bars						
Overall Belt Width						
Corner Radius (Rect. Only)						
		<input type="checkbox"/> Factory Splice	<input type="checkbox"/> Field Splice	<input type="checkbox"/> Factory Holes	<input type="checkbox"/> Field Holes	



## FABRIC EXPANSION JOINT APPLICATIONS

### Fossil Fired Power Plant

Typical balanced draft system with “cold” precipitator.  
The main sections of the ducting are as follows:

- FD Fan to Air Preheater
- Air Preheater to Boiler
- Air Preheater to Pulverizer
- Air Preheater Inlet from Boiler
- Air Preheater to Precipitator or Bag House
- Precipitator or Bag House to ID Fan
- ID Fan to Scrubber
- Scrubber to Stack

\*\*Plant conditions and expansion joint design features are detailed in this chapter. The examples to follow are representative and should not be used for design. The user should obtain the actual values for the particular system being considered.

**Note:** Black rings indicate fabric expansion joints

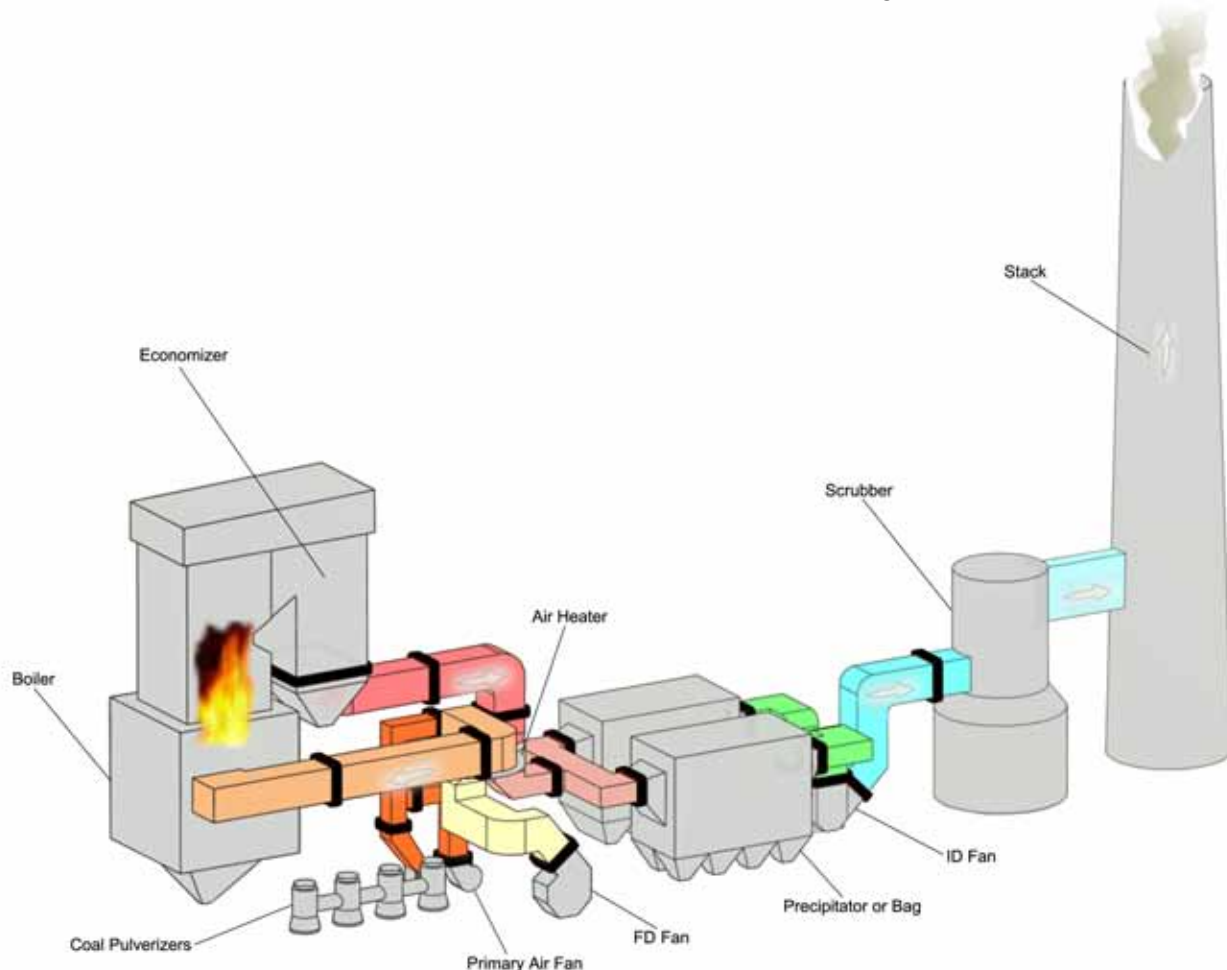

## APPLICATION: HIGH TEMPERATURE DIRTY FLUE GAS

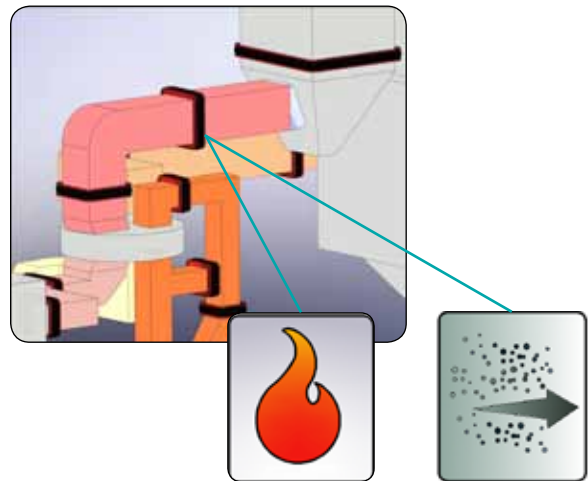
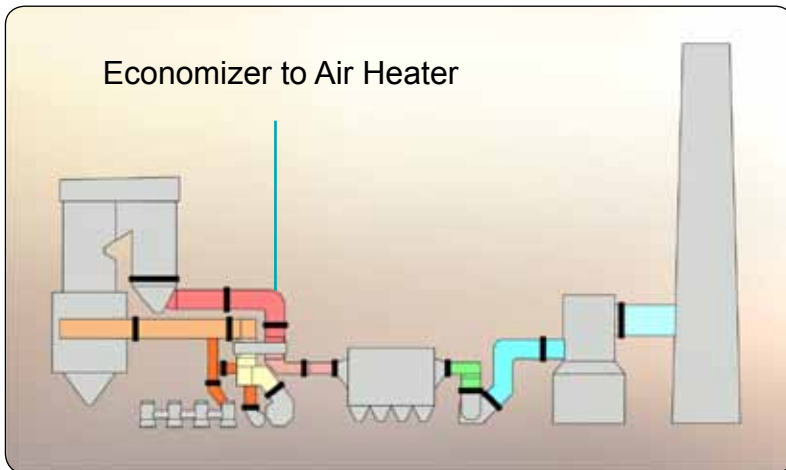

### Similar Applications

- **Fossil Fired Power Plant**  
Gas Recirculation System
- **Pulp and Paper Plant**  
Recovery Boiler to Precipitator
- **Refinery Turbo-Expander to CO Boiler and CO Boiler to Precipitator**
- **Cement Plant**  
Clinker Cooler to Heat Exchanger

### Typical Conditions

- 650°F to 850°F operating temperature
- -10" to -25" WG pressure
- Fuel gas media with heavy particulate
- Boiler growth contributes to large axial or lateral expansion joint movements depending on the orientation of the joints

Application	Operating	Design	Excursion	Duration (min)	
	Temperature (F)	800	850	1000	1 HOUR
	Pressure (inch H2O)	-25"	-25"	-30"	1 HOUR
	Movements	Compression	Extension	Lateral	Other
		3"	0.5"	2.5"	
Media :	<input type="checkbox"/> Air (clean) <input type="checkbox"/> Flue Gas <input checked="" type="checkbox"/> Dirty Flue Gas <input type="checkbox"/> Wet Flue Gas <input type="checkbox"/> Other				
	Flow Direction <b>HORIZONTAL</b>		Flow Velocity (Ft.Sec)		
Fabric Belt Material (If Known)					

### Sample Data Sheet for the Listed Applications

Blank data sheet on page 22.

Expansion Joint Style / Options	<input type="checkbox"/> Style 100B <input type="checkbox"/> Style 100W <input type="checkbox"/> Style 200B <input checked="" type="checkbox"/> Style 200W <input type="checkbox"/> Style 300B
	<input type="checkbox"/> Style 300W <input type="checkbox"/> Style 400B <input type="checkbox"/> Style 500B <input type="checkbox"/> Style 600B <input type="checkbox"/> Style 600W
	<input type="checkbox"/> Style 700B <input type="checkbox"/> Style 700W
Options	<input checked="" type="checkbox"/> Accumulation Pillow <input type="checkbox"/> Heat Seal Iron Kit (Rental) <input type="checkbox"/> Liner (Bolt on) <input type="checkbox"/> Heat Seal Iron Kit (Purchase) <input type="checkbox"/> Liner (Field Weld) <input type="checkbox"/> Drain Other







## RECOMMENDED EXPANSION JOINT DESIGNS

### Common Design Features:

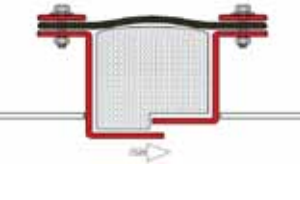
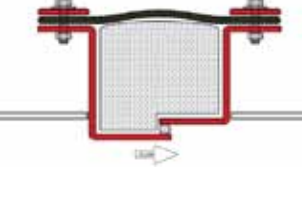
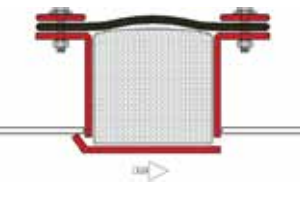
- **Fabric Belt:** High temperature fabric belt. (FLEXXCELL HT1, HT3, or HT5 depending on maximum temperature)
- **Standoff:** 6" minimum standoff and outboard belt attachment flanges to dissipate heat.
- **External Duct Insulation:** Contoured around expansion joint to allow heat dissipation.
- **Accumulation Barrier:** Fills expansion joint cavity to minimize the accumulation of particulate.

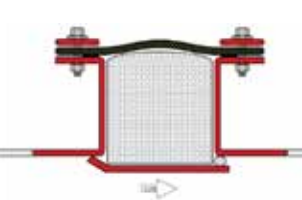
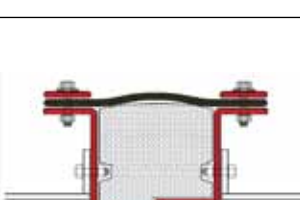
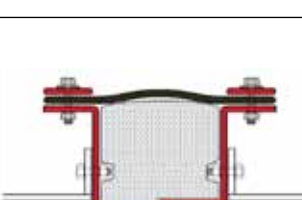
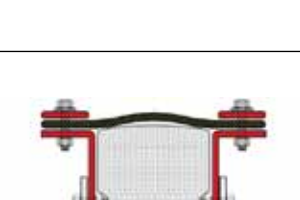
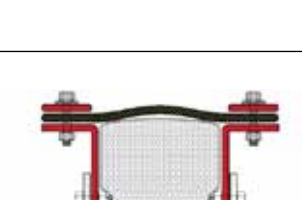
	Without Seal	With Seal	
<b>STYLE 200W</b>			<p><b>Design Performance:</b> *****</p> <p><b>Manufacturing Cost:</b> \$ \$ \$</p> <p><b>Installation Cost:</b> \$ \$</p> <p><b>Unique Design Features:</b></p> <ul style="list-style-type: none"> <li>• Field weld frame to duct.</li> <li>• Integral telescoping liners to retain the accumulation barrier and protect the belt from abrasion.</li> <li>• Specify with or without seal.</li> </ul>
<b>STYLE 100W</b>			<p><b>Design Performance:</b> ****</p> <p><b>Manufacturing Cost:</b> \$ \$</p> <p><b>Installation Cost:</b> \$ \$ \$</p> <p><b>Unique Design Features:</b></p> <ul style="list-style-type: none"> <li>• Field weld frame to duct.</li> <li>• Field weld liner to retain and protect the accumulation barrier and belt.</li> <li>• Specify with or without seal.</li> </ul>
<b>STYLE 300W</b>			<p><b>Design Performance:</b> ****</p> <p><b>Manufacturing Cost:</b> \$ \$ \$ \$</p> <p><b>Installation Cost:</b> \$ \$ \$</p> <p><b>Unique Design Features:</b></p> <ul style="list-style-type: none"> <li>• Field weld frame to duct.</li> <li>• Integral liner to retain and protect the accumulation barrier and belt.</li> <li>• Designed for large breach openings.</li> <li>• Specify with or without seal.</li> </ul>
<b>STYLE 200B</b>			<p><b>Design Performance:</b> *****</p> <p><b>Manufacturing Cost:</b> \$ \$ \$ \$</p> <p><b>Installation Cost:</b> \$ \$ \$ \$</p> <p><b>Unique Design Features:</b></p> <ul style="list-style-type: none"> <li>• Integral telescoping liners to retain and protect the accumulation barrier and belt.</li> <li>• Bolt in design for attachment to equipment or duct flanges.</li> <li>• Does require tack welding nuts.</li> <li>• Critical information required to insure proper fit-up.</li> <li>• Specify with or without seal.</li> </ul>
<b>STYLE 100B</b>			<p><b>Design Performance:</b> ****</p> <p><b>Manufacturing Cost:</b> \$ \$ \$</p> <p><b>Installation Cost:</b> \$ \$ \$ \$</p> <p><b>Unique Design Features:</b></p> <ul style="list-style-type: none"> <li>• Field weld liner to retain and protect the accumulation barrier and belt.</li> <li>• Bolt in design for attachment to equipment or duct flanges.</li> <li>• Does require tack welding nuts.</li> <li>• Critical information required to insure proper fit-up.</li> <li>• Specify with or without seal.</li> </ul>

## APPLICATION: HIGH TEMPERATURE CLEAN AIR

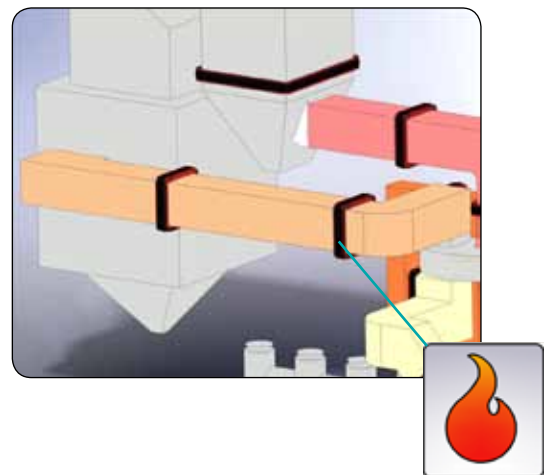
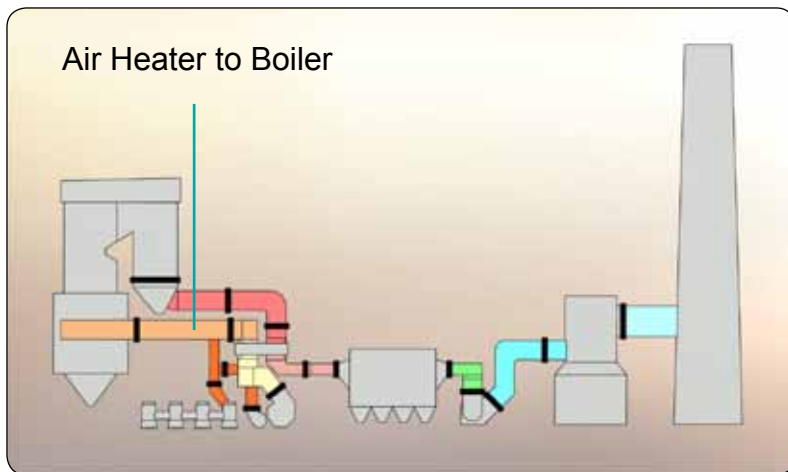

### Similar Applications

- **Fossil Fired Power Plant**  
Air Heater to Coal Pulverizers
- **Cement Plant**  
Clinker Cooler to Heat Exchanger





### Typical Conditions

- 600°F to 750°F operating temperature
- 5" to 80" WG pressure
- Clean air media
- Boiler growth contributes to large axial or lateral expansion joint movements depending on the orientation of the joints

Application	Operating	Design	Excursion	Duration (min)	
	Temperature (F)	700	750	800	1 HOUR
	Pressure (inch H2O)	80"	80"	100"	1 HOUR
	Movements	Compression	Extension	Lateral	Other
		3"	0.5"	2.5"	
Media :	<input checked="" type="checkbox"/> Air (clean) <input type="checkbox"/> Flue Gas <input type="checkbox"/> Dirty Flue Gas <input type="checkbox"/> Wet Flue Gas <input type="checkbox"/> Other				
	Flow Direction <b>HORIZONTAL</b>		Flow Velocity (Ft.Sec)		
Fabric Belt Material (If Known)					

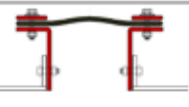
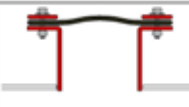
### Sample Data Sheet for the Listed Applications

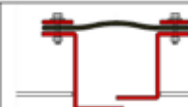
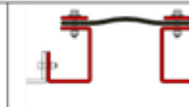
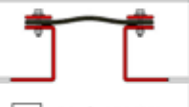
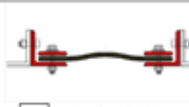
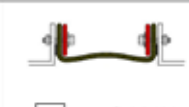
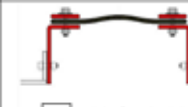
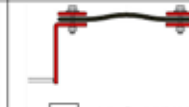
Blank data sheet on page 22.

Expansion Joint Style / Options	 <input type="checkbox"/> Style 100B	 <input type="checkbox"/> Style 100W	 <input type="checkbox"/> Style 200B	 <input checked="" type="checkbox"/> Style 200W	 <input type="checkbox"/> Style 300B
	 <input type="checkbox"/> Style 300W	 <input type="checkbox"/> Style 400B	 <input type="checkbox"/> Style 500B	 <input type="checkbox"/> Style 600B	 <input type="checkbox"/> Style 600W
	 <input type="checkbox"/> Style 700B	 <input type="checkbox"/> Style 700W	<b>Options</b> <input type="checkbox"/> Accumulation Pillow <input type="checkbox"/> Heat Seal Iron Kit (Rental) <input type="checkbox"/> Liner (Bolt on) <input type="checkbox"/> Heat Seal Iron Kit (Purchase) <input type="checkbox"/> Liner (Field Weld) <input type="checkbox"/> Drain Other		



# RECOMMENDED EXPANSION JOINT DESIGNS

## Common Design Features:

- **Fabric Belt:** High temperature fabric belt. (FLEXXCELL HT1, HT3, or HT5 depending on maximum temperature)
- **Standoff:** 6" minimum standoff and outboard belt attachment flanges to dissipate heat.
- **External Duct Insulation:** Contoured around expansion joint to allow heat dissipation.

<p><b>STYLE 200W</b></p>		<p><b>Design Performance:</b> * * * * *</p> <p><b>Manufacturing Cost:</b> \$ \$ \$</p> <p><b>Installation Cost:</b> \$ \$</p> <p><b>Unique Design Features:</b></p> <ul style="list-style-type: none"> <li>• Field weld frame to duct.</li> <li>• Integral telescoping liners to increase fabric material life.</li> </ul>
<p><b>STYLE 100W</b></p>		<p><b>Design Performance:</b> * * * *</p> <p><b>Manufacturing Cost:</b> \$ \$ \$</p> <p><b>Installation Cost:</b> \$ \$ \$</p> <p><b>Unique Design Features:</b></p> <ul style="list-style-type: none"> <li>• Field weld frame to duct.</li> <li>• Field weld liner to increase fabric material life.</li> </ul>
<p><b>STYLE 300W</b></p>		<p><b>Design Performance:</b> * * * *</p> <p><b>Manufacturing Cost:</b> \$ \$ \$ \$</p> <p><b>Installation Cost:</b> \$ \$ \$</p> <p><b>Unique Design Features:</b></p> <ul style="list-style-type: none"> <li>• Field weld frame to duct.</li> <li>• Integral liner to increase fabric material life.</li> </ul>
<p><b>STYLE 200B</b></p>		<p><b>Design Performance:</b> * * * * *</p> <p><b>Manufacturing Cost:</b> \$ \$ \$ \$</p> <p><b>Installation Cost:</b> \$ \$ \$ \$</p> <p><b>Unique Design Features:</b></p> <ul style="list-style-type: none"> <li>• Integral telescoping liners to increase fabric material life.</li> <li>• Bolt in design for attachment to equipment or duct flanges.</li> <li>• Does require tacking welding nuts.</li> <li>• Critical information required to insure proper fit-up.</li> </ul>
<p><b>STYLE 100B</b></p>		<p><b>Design Performance:</b> * * * * *</p> <p><b>Manufacturing Cost:</b> \$ \$ \$ \$</p> <p><b>Installation Cost:</b> \$ \$ \$ \$</p> <p><b>Unique Design Features:</b></p> <ul style="list-style-type: none"> <li>• Field weld liner to increase fabric material life.</li> <li>• Bolt in design for attachment to equipment or duct flanges.</li> <li>• Does require tack welding nuts.</li> <li>• Critical information required to insure proper fit-up.</li> </ul>

## APPLICATION: TURBULENT AIR

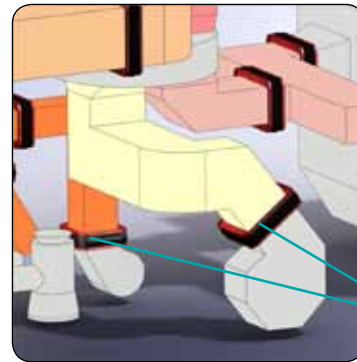
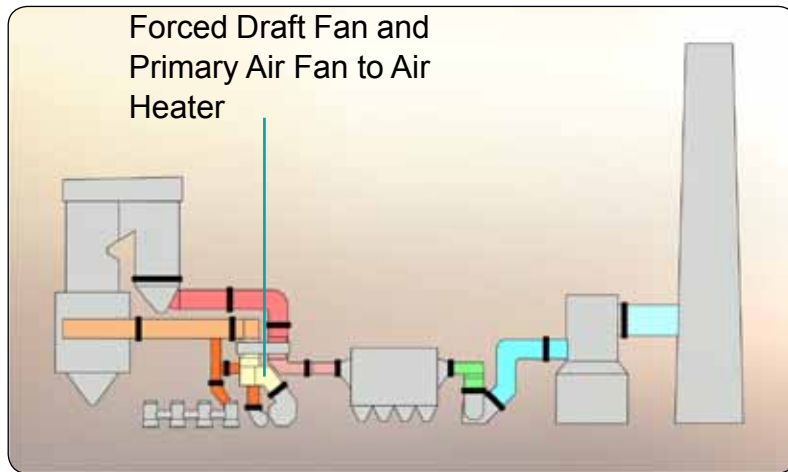

### Similar Applications

- **Pulp and Paper Plant**  
Primary Air to Recovery Boiler

### Typical Conditions

- Ambient temperature
- 40" to 50" WG pressure
- Clean air
- Movement mainly limited to vibrations

Application	Operating	Design	Excursion	Duration (min)	
	Temperature (F)	100	100		
	Pressure (inch H2O)	50"	80"		
	Movements	Compression 0.5"	Extension 0.5"	Lateral 2.5"	Other
Media :	<input checked="" type="checkbox"/> Air (clean) <input type="checkbox"/> Flue Gas <input type="checkbox"/> Dirty Flue Gas <input type="checkbox"/> Wet Flue Gas <input type="checkbox"/> Other				
	Flow Direction <b>45 DEG UP</b>		Flow Velocity (Ft.Sec)		
Fabric Belt Material (If Known)					

### Sample Data Sheet for the Listed Applications

Blank data sheet on page 22.

Expansion Joint Style / Options	Expansion Joint Styles					Options	
	<input type="checkbox"/> Style 100B	<input type="checkbox"/> Style 100W	<input checked="" type="checkbox"/> Style 200B	<input type="checkbox"/> Style 200W	<input type="checkbox"/> Style 300B		<input type="checkbox"/> Accumulation Pillow <input type="checkbox"/> Heat Seal Iron Kit (Rental) <input type="checkbox"/> Liner (Bolt on) <input type="checkbox"/> Heat Seal Iron Kit (Purchase) <input type="checkbox"/> Liner (Field Weld) <input type="checkbox"/> Drain Other
	<input type="checkbox"/> Style 300W	<input type="checkbox"/> Style 400B	<input type="checkbox"/> Style 500B	<input type="checkbox"/> Style 600B	<input type="checkbox"/> Style 600W		
<input type="checkbox"/> Style 700B	<input type="checkbox"/> Style 700W						





## RECOMMENDED EXPANSION JOINT DESIGNS

### Common Design Features:

- **Fabric Belt:** At fan locations, a flutter resistant fabric belt material should be used. (FLEXXCEL FF1)
- **Standoff:** Bolt-in design for attachment to equipment or duct flanges.
- **External Duct Insulation:** Flow liner to reduce turbulence/flutter of fabric belt material.

<p><b>STYLE 200B</b></p>		<p><b>Design Performance:</b> * * * * *</p> <p><b>Manufacturing Cost:</b> \$ \$ \$ \$ \$</p> <p><b>Installation Cost:</b> \$ \$ \$ \$</p> <p><b>Unique Design Features:</b></p> <ul style="list-style-type: none"> <li>• Integral telescoping liners.</li> <li>• Does not require tack welding nuts.</li> </ul>
<p><b>STYLE 100B</b></p>		<p><b>Design Performance:</b> * * * *</p> <p><b>Manufacturing Cost:</b> \$ \$ \$</p> <p><b>Installation Cost:</b> \$ \$ \$ \$ \$</p> <p><b>Unique Design Features:</b></p> <ul style="list-style-type: none"> <li>• Field weld liner.</li> <li>• Does not require tack welding nuts.</li> </ul>
<p><b>STYLE 300B</b></p>		<p><b>Design Performance:</b> * * * *</p> <p><b>Manufacturing Cost:</b> \$ \$ \$ \$ \$</p> <p><b>Installation Cost:</b> \$ \$ \$</p> <p><b>Unique Design Features:</b></p> <ul style="list-style-type: none"> <li>• Integral liner.</li> <li>• Ease of pre-compression for installing in breach opening.</li> <li>• Does not require tack welding nuts.</li> </ul>
<p><b>STYLE 400B</b></p>		<p><b>Design Performance:</b> * * *</p> <p><b>Manufacturing Cost:</b> \$ \$ \$</p> <p><b>Installation Cost:</b> \$ \$ \$</p> <p><b>Unique Design Features:</b></p> <ul style="list-style-type: none"> <li>• Integral liner.</li> <li>• Ease of pre-compression for installing in breach opening.</li> <li>• Requires belt attachment nuts to be tack welded.</li> </ul>
<p><b>STYLE 500B</b></p>		<p><b>Design Performance:</b> * * *</p> <p><b>Manufacturing Cost:</b> \$ \$ \$</p> <p><b>Installation Cost:</b> \$ \$ \$</p> <p><b>Unique Design Features:</b></p> <ul style="list-style-type: none"> <li>• Bolt-on liner.</li> <li>• Flanges on fabric belt attach directly to duct flange or equipment.</li> </ul>

## APPLICATION: DIRTY FLUE GAS

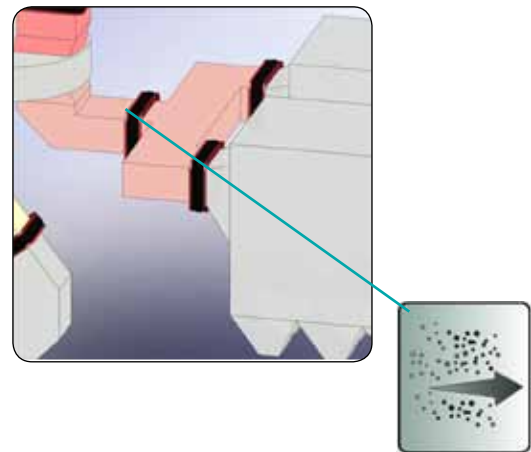
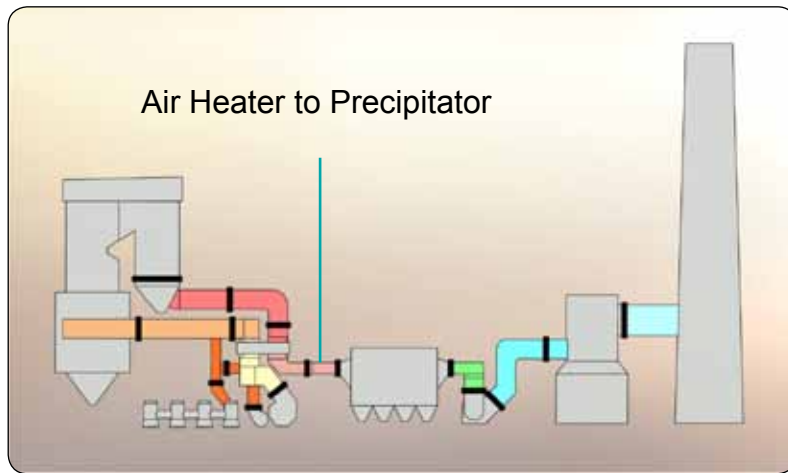

### Similar Applications

- **Cement Plant**  
Preheater Tower
- **Refinery**  
CO Boiler to Precipitator

### Typical Conditions

- 250°F to 500°F operating temperature
- -35" to -50" WG pressure
- Flue gas with possible fly ash carry over through air heater
- Moderate thermal movements in ducting

Application	Operating	Design	Excursion	Duration (min)	
	Temperature (F)	500	600	700	1 HOUR
	Pressure (inch H2O)	-50"	-50"	-60	1 HOUR
	Movements	Compression 1.5"	Extension 0.5"	Lateral 1.0"	Other
Media :	<input type="checkbox"/> Air (clean) <input type="checkbox"/> Flue Gas <input checked="" type="checkbox"/> Dirty Flue Gas <input type="checkbox"/> Wet Flue Gas   Other				
	Flow Direction <b>HORIZONTAL</b>		Flow Velocity (Ft.Sec)		
Fabric Belt Material (If Known)					

**Sample Data Sheet for the Listed Applications**

Blank data sheet on page 22.

Expansion Joint Style / Options	Expansion Joint Styles				
	<input type="checkbox"/> Style 100B	<input type="checkbox"/> Style 100W	<input type="checkbox"/> Style 200B	<input checked="" type="checkbox"/> Style 200W	<input type="checkbox"/> Style 300B
	<input type="checkbox"/> Style 300W	<input type="checkbox"/> Style 400B	<input type="checkbox"/> Style 500B	<input type="checkbox"/> Style 600B	<input type="checkbox"/> Style 600W
<input type="checkbox"/> Style 700B	<input type="checkbox"/> Style 700W	<b>Options</b> <input checked="" type="checkbox"/> Accumulation Pillow <input type="checkbox"/> Heat Seal Iron Kit (Rental) <input type="checkbox"/> Liner (Bolt on) <input type="checkbox"/> Heat Seal Iron Kit (Purchase) <input type="checkbox"/> Liner (Field Weld) <input type="checkbox"/> Drain Other			



## RECOMMENDED EXPANSION JOINT DESIGNS

### Common Design Features:

- **Fabric Belt:** Un-insulated fabric material. (FLEXXCEL HD7)
- **Accumulation Barrier:** Fills expansion joint cavity to minimize the accumulation of particulate.
- **Liner:** Flow liner to retain the accumulation barrier and protect the belt from abrasion.

<p>STYLE 200W</p>		<p><b>Design Performance:</b> * * * * *</p> <p><b>Manufacturing Cost:</b> \$ \$ \$</p> <p><b>Installation Cost:</b> \$ \$</p> <p><b>Unique Design Features:</b></p> <ul style="list-style-type: none"> <li>• Integral telescoping liners to retain the accumulation barrier and protect the belt from abrasion.</li> </ul>
<p>STYLE 100W</p>		<p><b>Design Performance:</b> * * *</p> <p><b>Manufacturing Cost:</b> \$ \$ \$</p> <p><b>Installation Cost:</b> \$ \$ \$</p> <p><b>Unique Design Features:</b></p> <ul style="list-style-type: none"> <li>• Field weld liner.</li> </ul>
<p>STYLE 300W</p>		<p><b>Design Performance:</b> * * *</p> <p><b>Manufacturing Cost:</b> \$ \$ \$</p> <p><b>Installation Cost:</b> \$ \$ \$</p> <p><b>Unique Design Features:</b></p> <ul style="list-style-type: none"> <li>• Integral liner.</li> </ul>
<p>STYLE 600W</p>		<p><b>Design Performance:</b> * * *</p> <p><b>Manufacturing Cost:</b> \$ \$ \$ \$</p> <p><b>Installation Cost:</b> \$ \$ \$ \$</p> <p><b>Unique Design Features:</b></p> <ul style="list-style-type: none"> <li>• Field weld liner.</li> <li>• Ease of pre-compression for installing in breach opening.</li> <li>• Requires belt attachment nuts to be tack welded.</li> <li>• Leakage around belt attachment fasteners possible.</li> </ul>
<p>STYLE 700W</p>		<p><b>Design Performance:</b> * * *</p> <p><b>Manufacturing Cost:</b> \$ \$ \$</p> <p><b>Installation Cost:</b> \$ \$ \$</p> <p><b>Unique Design Features:</b></p> <ul style="list-style-type: none"> <li>• Belt installed and replaced from inside the duct.</li> <li>• Field weld liner.</li> <li>• Ease of pre-compression for installing in breach opening.</li> <li>• Requires belt attachment nuts to be tack welded.</li> <li>• Leakage around belt attachment fasteners possible.</li> </ul>

## APPLICATION: TURBULENT FLUE GAS, WET GAS

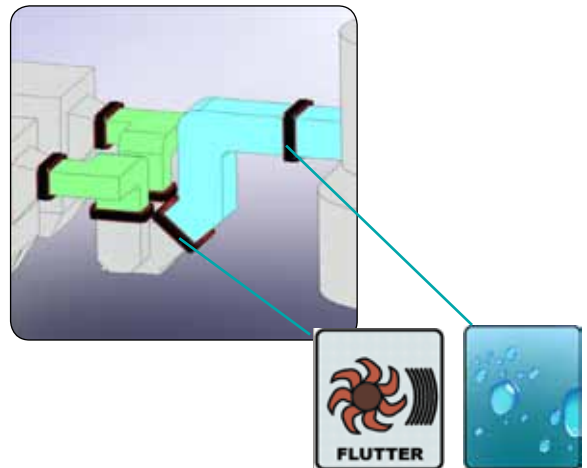
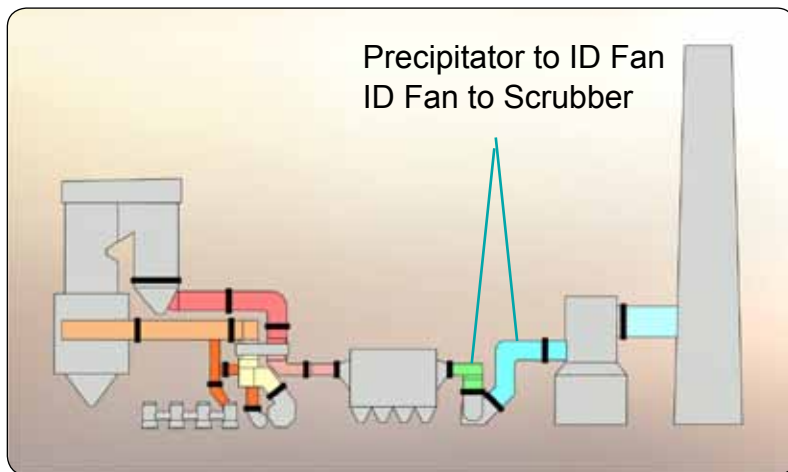

### Similar Applications

- **Fossil Fired Power Plant**  
Re-heater to Chimney
- **Pulp and Paper Plant**  
Induced Draft Fan to Chimney
- **Refinery**  
Steam Generator to Stack

### Typical Conditions

- 250°F to 500°F operating temperature
- -35" to +50" WG pressure
- Minimal particulate downstream of precipitator.  
Potential for wet conditions

Application	Operating	Design	Excursion	Duration (min)	
	Temperature (F)	500	600	700	1 HOUR
	Pressure (inch H2O)	50"	50"		
	Movements	Compression 1.0"	Extension 0.5"	Lateral 0.75"	Other
Media :	<input type="checkbox"/> Air (clean)	<input type="checkbox"/> Flue Gas	<input type="checkbox"/> Dirty Flue Gas	<input checked="" type="checkbox"/> Wet Flue Gas	<input type="checkbox"/> Other
	Flow Direction <b>HORIZONTAL</b>		Flow Velocity (Ft.Sec)		
Fabric Belt Material (If Known)					

**Sample Data Sheet for the Listed Applications**

Blank data sheet on page 22.

Expansion Joint Style / Options	 <input type="checkbox"/> Style 100B	 <input type="checkbox"/> Style 100W	 <input checked="" type="checkbox"/> Style 200B	 <input type="checkbox"/> Style 200W	 <input type="checkbox"/> Style 300B
	 <input type="checkbox"/> Style 300W	 <input type="checkbox"/> Style 400B	 <input type="checkbox"/> Style 500B	 <input type="checkbox"/> Style 600B	 <input type="checkbox"/> Style 600W
	 <input type="checkbox"/> Style 700B	 <input type="checkbox"/> Style 700W	<b>Options</b> <input type="checkbox"/> Accumulation Pillow <input type="checkbox"/> Heat Seal Iron Kit (Rental) <input type="checkbox"/> Liner (Bolt on) <input type="checkbox"/> Heat Seal Iron Kit (Purchase) <input type="checkbox"/> Liner (Field Weld) <input type="checkbox"/> Drain Other		





## RECOMMENDED EXPANSION JOINT DESIGNS

### Common Design Features:

- **Fabric Belt:** At fan locations, the belt material should have a high resistance to flutter. (FLEXXCEL FF1)
- **Frame Attachment:** Bolt-in design for attachment to equipment or duct flanges. (If equipment or duct flanges are not present, Weld-In designs are recommended.)
- **Liner:** Flow liner to retain the accumulation barrier and protect the belt from abrasion.

<p><b>STYLE 200B</b></p>		<p><b>Design Performance:</b> * * * * *</p> <p><b>Manufacturing Cost:</b> \$ \$ \$ \$</p> <p><b>Installation Cost:</b> \$ \$ \$ \$</p> <p><b>Unique Design Features:</b></p> <ul style="list-style-type: none"> <li>• Integral telescoping liners.</li> <li>• Does require tack welding nuts.</li> </ul>
<p><b>STYLE 100B</b></p>		<p><b>Design Performance:</b> * * * *</p> <p><b>Manufacturing Cost:</b> \$ \$ \$ \$</p> <p><b>Installation Cost:</b> \$ \$ \$ \$</p> <p><b>Unique Design Features:</b></p> <ul style="list-style-type: none"> <li>• Field weld liner.</li> <li>• Does require tack welding nuts.</li> </ul>
<p><b>STYLE 300B</b></p>		<p><b>Design Performance:</b> * * * *</p> <p><b>Manufacturing Cost:</b> \$ \$ \$ \$ \$</p> <p><b>Installation Cost:</b> \$ \$ \$ \$</p> <p><b>Unique Design Features:</b></p> <ul style="list-style-type: none"> <li>• Integral liner.</li> <li>• Ease of pre-compression for installing in breach opening.</li> <li>• Does not require tack welding nuts.</li> </ul>
<p><b>STYLE 400B</b></p>		<p><b>Design Performance:</b> * *</p> <p><b>Manufacturing Cost:</b> \$ \$ \$ \$ \$</p> <p><b>Installation Cost:</b> \$ \$ \$ \$</p> <p><b>Unique Design Features:</b></p> <ul style="list-style-type: none"> <li>• Integral liner.</li> <li>• Ease of pre-compression for installing in breach opening.</li> <li>• Requires belt attachment nuts to be tack welded.</li> <li>• Not recommended in negative pressure applications before ID fan.</li> </ul>
<p><b>STYLE 500B</b></p>		<p><b>Design Performance:</b> * *</p> <p><b>Manufacturing Cost:</b> \$ \$ \$</p> <p><b>Installation Cost:</b> \$ \$ \$</p> <p><b>Unique Design Features:</b></p> <ul style="list-style-type: none"> <li>• Bolt-on liner.</li> <li>• Flanges on fabric belt attach directly to duct flange or equipment. Not recommended in negative pressure applications before ID fan.</li> </ul>

## APPLICATION: LOW TEMPERATURE WET FLUE GAS

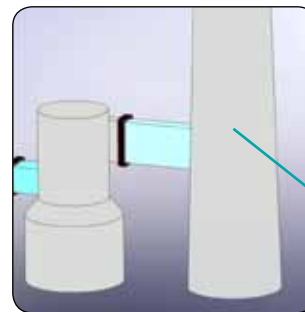
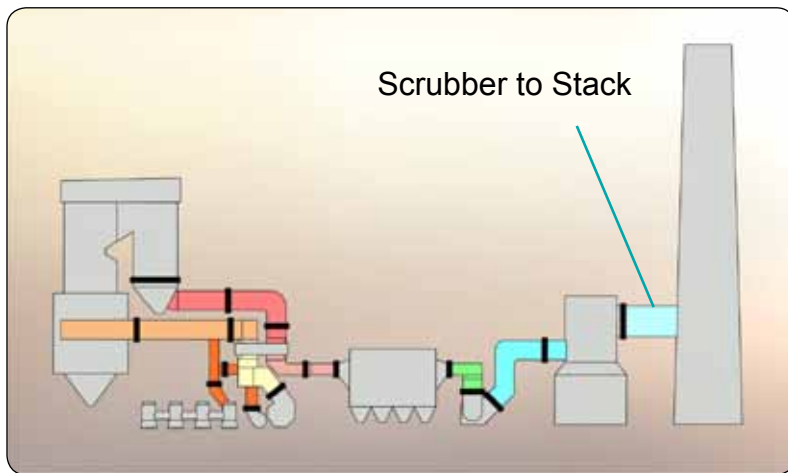

### Similar Applications

- **Fossil Fired Power Plant**  
Scrubber Bypass to Stack and Scrubber to Re-heater
- **Pulp and Paper Plant**  
Scrubber Inlet and Scrubber to Re-heater

### Typical Conditions

- 120°F to 350°F operating temperature
- +5" to +15" WG pressure
- Minimal particulate
- Highly corrosive wet gas
- Minimal movements

Application	Operating	Design	Excursion	Duration (min)	
	Temperature (F)	350	600	700	1 HOUR
	Pressure (inch H2O)	15"	15"		
	Movements	Compression	Extension	Lateral	Other
		0.5"	0.5"	0.5"	
Media :	<input type="checkbox"/> Air (clean)	<input type="checkbox"/> Flue Gas	<input type="checkbox"/> Dirty Flue Gas	<input checked="" type="checkbox"/> Wet Flue Gas	<input type="checkbox"/> Other
	Flow Direction <b>HORIZONTAL</b>		Flow Velocity (Ft.Sec)		
Fabric Belt Material (If Known)					

**Sample Data Sheet for the Listed Applications**

Blank data sheet on page 22.

Expansion Joint Style / Options	<input type="checkbox"/> Style 100B	<input checked="" type="checkbox"/> Style 100W	<input type="checkbox"/> Style 200B	<input type="checkbox"/> Style 200W	<input type="checkbox"/> Style 300B
	<input type="checkbox"/> Style 300W	<input type="checkbox"/> Style 400B	<input type="checkbox"/> Style 500B	<input type="checkbox"/> Style 600B	<input type="checkbox"/> Style 600W
	<input type="checkbox"/> Style 700B	<input type="checkbox"/> Style 700W	<b>Options</b> <input type="checkbox"/> Accumulation Pillow <input type="checkbox"/> Heat Seal Iron Kit (Rental) <input type="checkbox"/> Liner (Bolt on) <input type="checkbox"/> Heat Seal Iron Kit (Purchase) <input type="checkbox"/> Liner (Field Weld) <input checked="" type="checkbox"/> Drain Other		

## RECOMMENDED EXPANSION JOINT DESIGNS

### Common Design Features:

- **Fabric Belt:** Fabric material should have the maximum chemical barrier due to corrosive conditions. (FLEXXCEL HC 40)

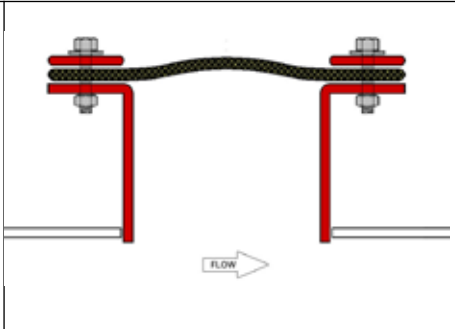
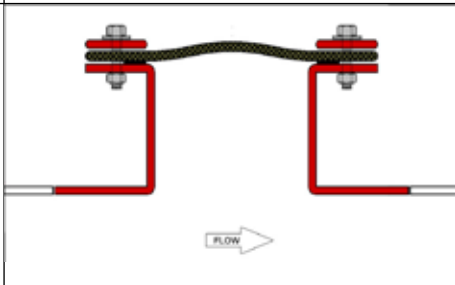
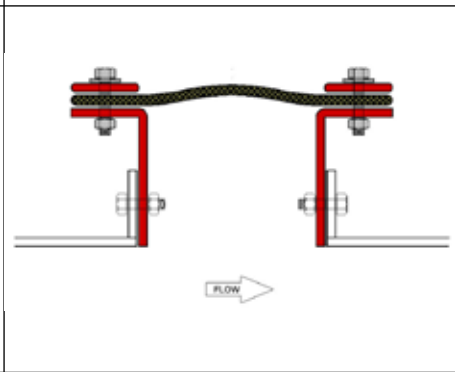
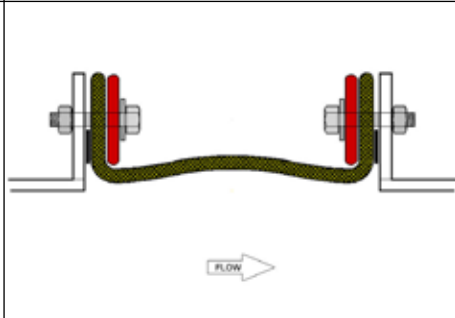
<p>STYLE 100W</p>		<p><b>Design Performance:</b> * * * *</p> <p><b>Manufacturing Cost:</b> \$ \$</p> <p><b>Installation Cost:</b> \$ \$ \$</p> <p><b>Unique Design Features:</b></p> <ul style="list-style-type: none"> <li>• Welds to duct.</li> </ul>
<p>STYLE 300W</p>		<p><b>Design Performance:</b> * * * *</p> <p><b>Manufacturing Cost:</b> \$ \$ \$ \$</p> <p><b>Installation Cost:</b> \$ \$ \$</p> <p><b>Unique Design Features:</b></p> <ul style="list-style-type: none"> <li>• Ease of pre-compression for installing in breach opening.</li> <li>• Does not require tack welding nuts.</li> </ul>
<p>STYLE 100B</p>		<p><b>Design Performance:</b> * * * *</p> <p><b>Manufacturing Cost:</b> \$ \$ \$</p> <p><b>Installation Cost:</b> \$ \$ \$ \$</p> <p><b>Unique Design Features:</b></p> <ul style="list-style-type: none"> <li>• Bolts to duct.</li> <li>• Does require tack welding nuts.</li> </ul>
<p>STYLE 500B</p>		<p><b>Design Performance:</b> * *</p> <p><b>Manufacturing Cost:</b> \$ \$ \$</p> <p><b>Installation Cost:</b> \$ \$ \$</p> <p><b>Unique Design Features:</b></p> <ul style="list-style-type: none"> <li>• Flanges on fabric belt attach directly to duct flange or equipment.</li> </ul>

## FRAME DESIGNS

Fabric expansion joints consist of two major components – the fabric belt material and the metal frame. The frame can connect to the ducting by welding or bolting.

Pages 37 to 41 will detail the frame styles offered by U.S. Bellows. Each U.S. Bellows frame style has features designed to minimize the detrimental effects of temperature, movements, pressure, media, and turbulence. The U.S. Bellows team is experienced in evaluating application conditions and implementing designs that lead to long term expansion joint service.

Design alterations can include the following:

- Adequate standoff height
- Adequate face-to-face dimension
- Inclusion of liner
- Frame material
- Belt material
- Inclusion of accumulation barrier
- Inclusion of insulation pillow
- Proper bolt hole spacing
- And more

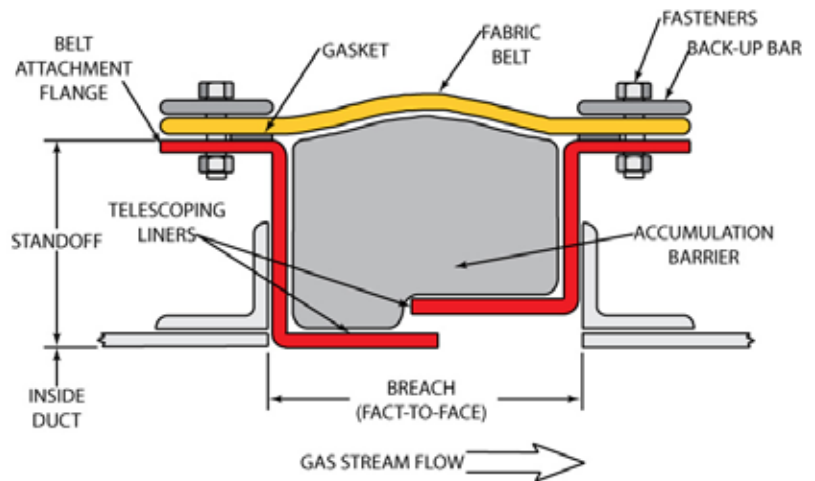

Although U.S. Bellows can provide weld-in and bolt-in frame styles, wherever possible, it is strongly recommended that the expansion joint be welded in place.

Benefits of weld-in designs include:



- Weld-in designs are less expensive to manufacture.
- Accurate field bolt hole dimensional data can be difficult to obtain and verify.
- Welded connections can accommodate “real world” field conditions and inaccuracies that occur during installation.



## FLEXXCEL EXPANSION JOINT FRAME STYLES

### Weld-In Designs

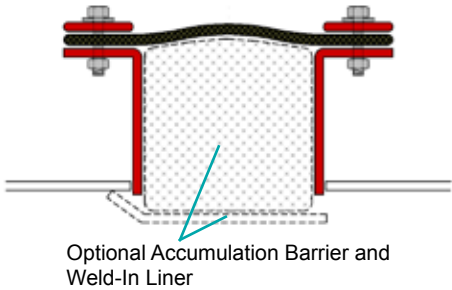

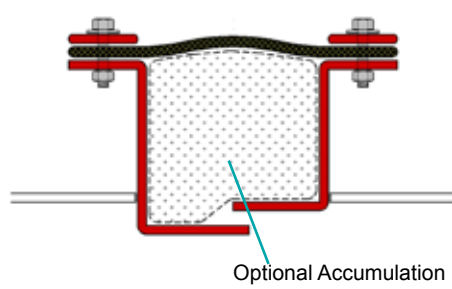
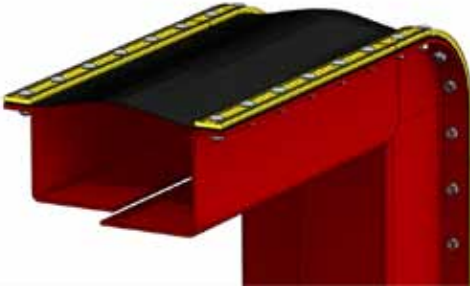
The following frame styles allow the expansion joint to weld directly to the duct or duct flanges. These frame styles are basic designs that can be augmented with optional components shown on pages 42 to 44.

Design Features	Typical Cross Sections	Rectangular Expansion Joint Typical Corner Details
<p>1 2 3</p>	<p><b>Style 100 W</b></p>  <p>Optional Accumulation Barrier and Weld-In Liner</p>	
<p>1 2 3 5 6</p>	<p><b>Style 200 W</b></p>  <p>Optional Accumulation Barrier</p>	

### Design Feature Legend

1. Outboard belt attachment flanges keep fabric metal cool at the attachment area.
2. Provides standoff of fabric belt from media.
3. Flat belt design for maximum belt life, ease of replacement, and composite construction options.
4. Inboard flanges should not be used in applications where the temperature exceeds the fabric material rating.
5. Integral telescoping liners offer the best protection from abrasion.
6. Superior design for pinning insulation pillows to liners.
7. Requires tack welding nuts to frame.

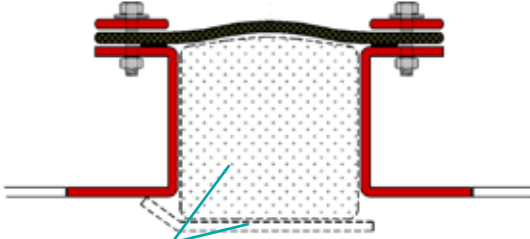
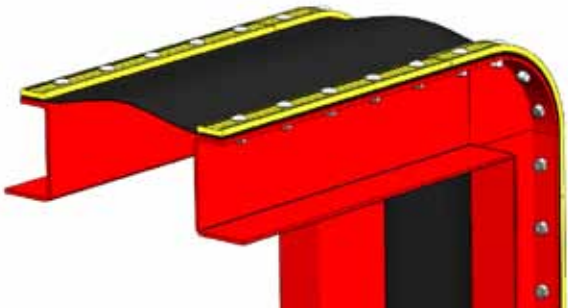
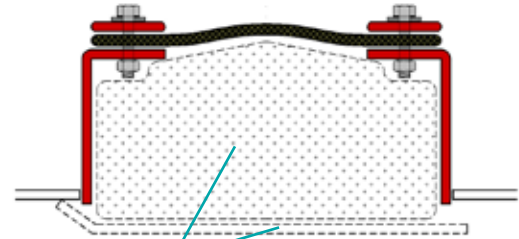
## Weld-In Designs

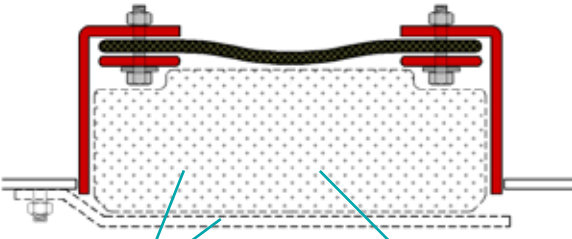
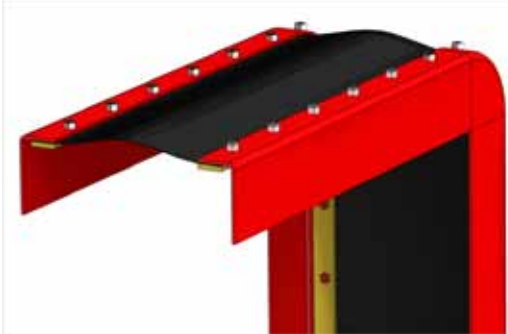
Design Features	Typical Cross Sections	Rectangular Expansion Joint Typical Corner Details
1 2 3	<p><b>Style 300 W</b></p>  <p>Optional Accumulation Barrier and Weld-In liner</p>	
2 3 4 7	<p><b>Style 600 W</b></p>  <p>Optional Accumulation Barrier and Weld-In liner</p>	
2 3 4 7	<p><b>Style 700 W</b></p>  <p>Optional Accumulation Barrier and Weld-In liner</p> <p>Allows for belt replacement from inside duct.</p>	

## Bolt In Designs



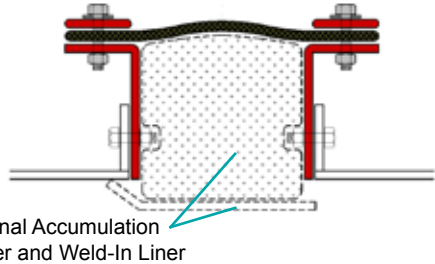
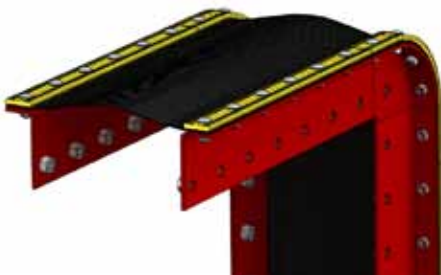
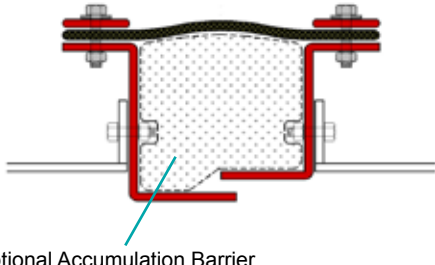
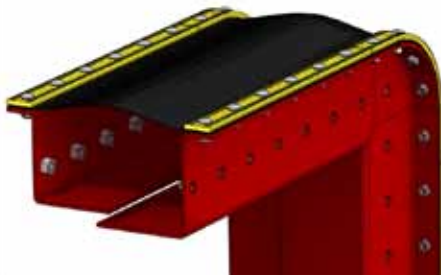

The following frame styles allow the expansion joint to bolt directly to duct flanges or equipment flanges supplied by others. These bolt in designs are generally more expensive to manufacture and are potentially more difficult to install due to hole pattern irregularities and inaccuracies. These frame styles are basic designs that can be enhanced with the optional components shown on pages 42 to 44.

Design Features	Typical Cross Sections	Rectangular Expansion Joint Typical Corner Details
<p>1 2 3 7</p>	<p><b>Style 100 B</b></p>  <p>Optional Accumulation Barrier and Weld-In Liner</p>	
<p>1 2 3 5 6 7</p>	<p><b>Style 200 B</b></p>  <p>Optional Accumulation Barrier</p>	

## Design Feature Legend

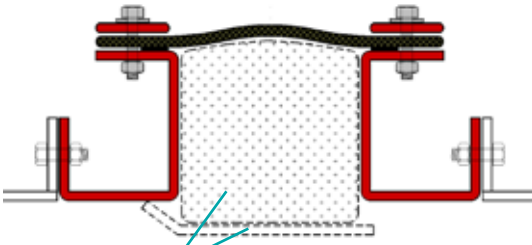
1. Outboard attachment flanges keep fabric material cool at the attachment area.
2. Provides standoff of fabric belt from media.
3. Flat belt design for maximum belt life, ease of replacement, and composite constructions options.
4. Inboard flanges should not be used in applications where the temperature exceeds the fabric material rating.
5. Integral telescoping liners offer the best protection from abrasion.
6. Superior design for pinning insulation pillows to liners.
7. Requires tack welding nuts to frame.

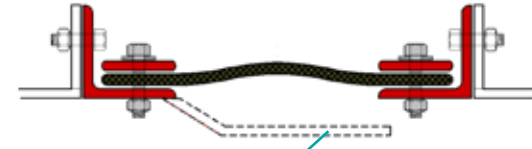
## Bolt In Designs

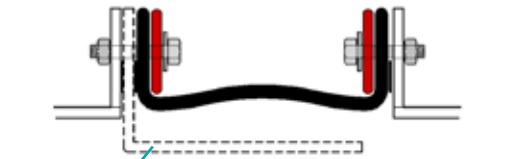
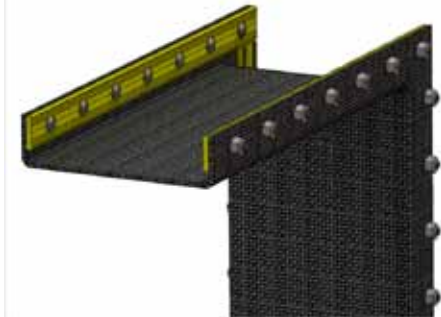
Design Features	Typical Cross Sections	Rectangular Expansion Joint Typical Corner Details
<p>1 2 3</p>	<p><b>Style 300 B</b></p>  <p>Optional Accumulation Barrier and Weld-In Liner</p>	
<p>3 4 7</p>	<p><b>Style 400 B</b></p>  <p>Optional Weld-In Liner</p>	
<p>4</p>	<p><b>Style 500 B</b></p>  <p>Optional Weld-In Liner    Integral belt flange allows bolting directly to equipment.</p>	

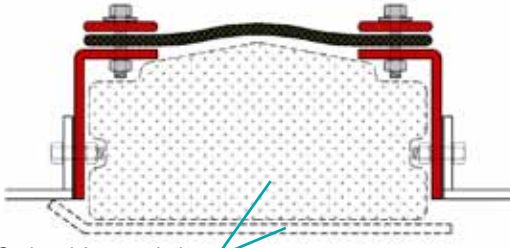
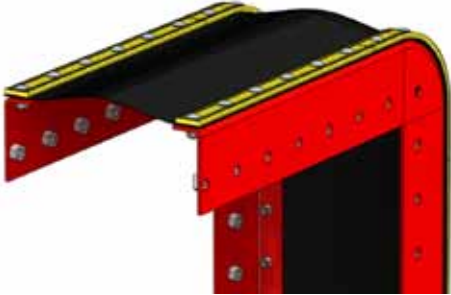
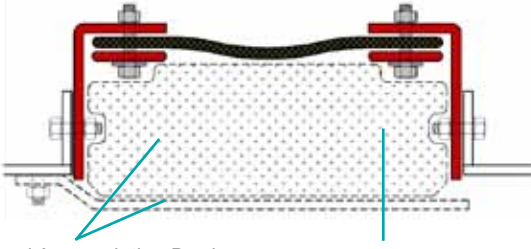
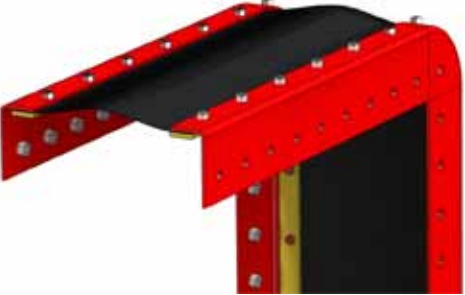

## Bolt In Designs

Design Features	Typical Cross Sections	Rectangular Expansion Joint Typical Corner Details
<p>2 3 4 7</p>	<p><b>Style 600 B</b></p>  <p>Optional Accumulation Barrier Weld-In Liner</p>	
<p>2 3 4 7</p>	<p><b>Style 700 B</b></p>  <p>Optional Accumulation Barrier and Weld-In Liner</p> <p>Allows for belt replacement from inside of duct.</p>	

## Design Feature Legend

1. Outboard belt attachment flanges keep fabric material cool at the attachment area.
2. Provides standoff of fabric belt from media.
3. Flat belt design for maximum belt life, ease of replacement, and composite construction options.
4. Inboard flanges should not be used in applications where the temperature exceeds the fabric material rating.
5. Integral telescoping liners offer the best protection from abrasion.
6. Superior design for pinning insulation pillows to liners.
7. Requires tack welding nuts to frame.

## FLEXXCEL EXPANSION JOINT COMPONENTS

In addition to the standard frame styles shown on the previous pages, U.S. Bellows can provide additional components that are designed to augment certain styles in specific applications.

### Accumulation Barrier For Applications with Particulate

The accumulation barrier option provides a flexible, low density barrier for fly ash or dust accumulation in the expansion joint cavity. It can be provided for any design that includes a flow liner. The barrier typically is constructed with low density fiberglass material wrapped in aluminized fiberglass cloth and wire mesh. In applications with large movements, the barrier can be constructed with “ears” that are clamped under the backing bars.

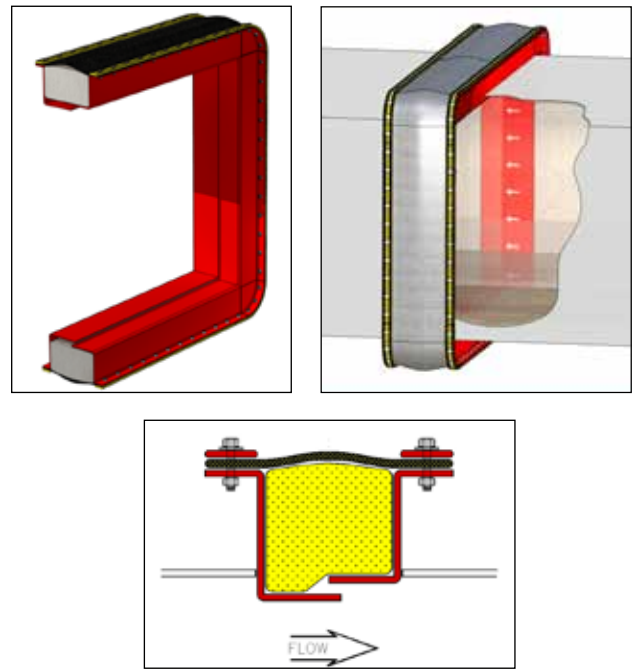

### Insulation Pillow for High Temperature Applications

The insulation pillow option ensures that the temperature at the gas seal membrane does not exceed its capability. The insulation pillow is constructed with high density needle felted ceramic insulation wrapped with high temperature cloth and wire mesh. The insulation pillow is pinned snugly to the liners or frames.

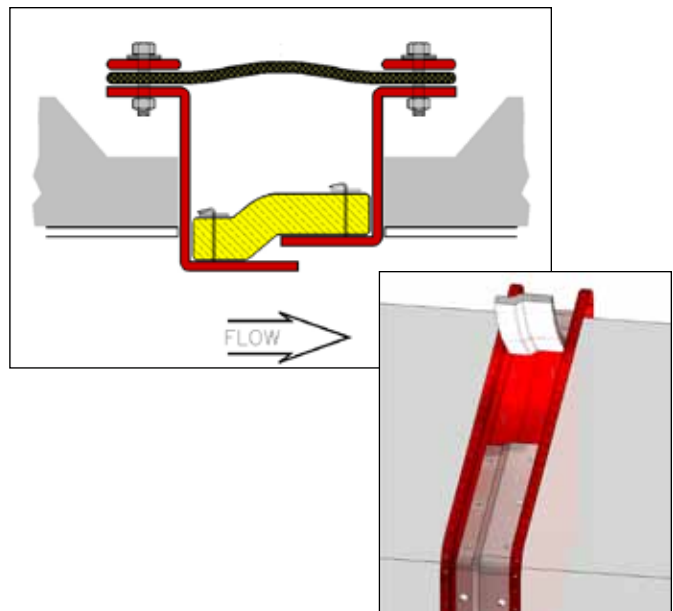

## FLEXXCEL EXPANSION JOINT COMPONENTS

### Bolt-On Liner for Style 500

The liner is attached with the fasteners of the upstream clamping bar.

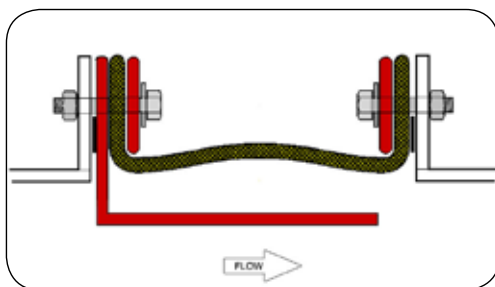

### Bolt-On Liner for Style 700

The liner is designed to be removed from inside the ducting to allow access to the fabric belt. The liner is attached with studs field welded inside the duct.

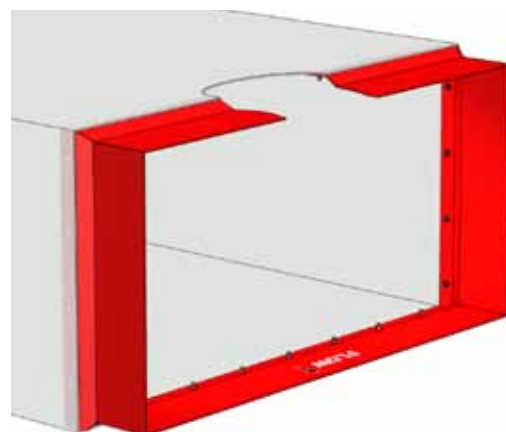
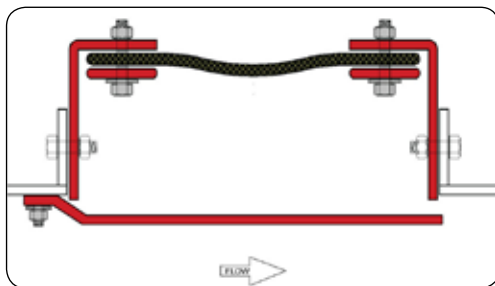

### Weld-On Liner for Style 100, 600

The liner is field welded to the upstream inside edge of the duct. (3D view similar to Style 700, pictured above, except without studs.)

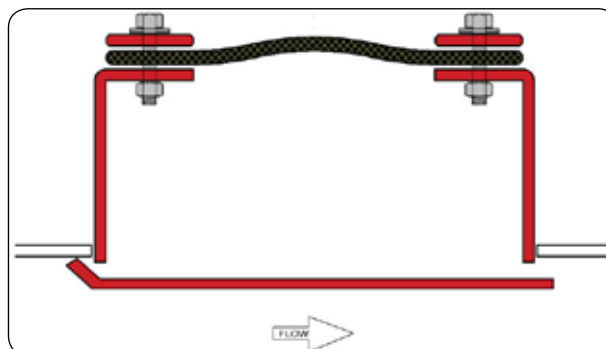

## FLEXXCEL EXPANSION JOINT COMPONENTS

### Drain

A drain fitting machined out of PTFE material can be installed in the belt at the bottom of the expansion joint. If conditions are wet enough to cause pooling, specify a drain.

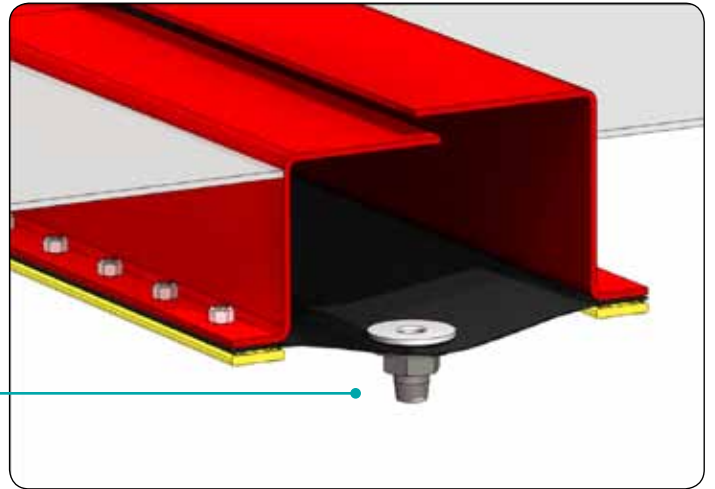

### Particulate Deflector

In certain conditions, a particulate deflector can be specified to reduce airborne particulate from falling down into the expansion joint cavity. This is most common on vertical ducting with the flow direction up and an upstream liner overlapping the downstream duct. The deflector presents an angled surface to the flow and eliminates a ledge for build-up.

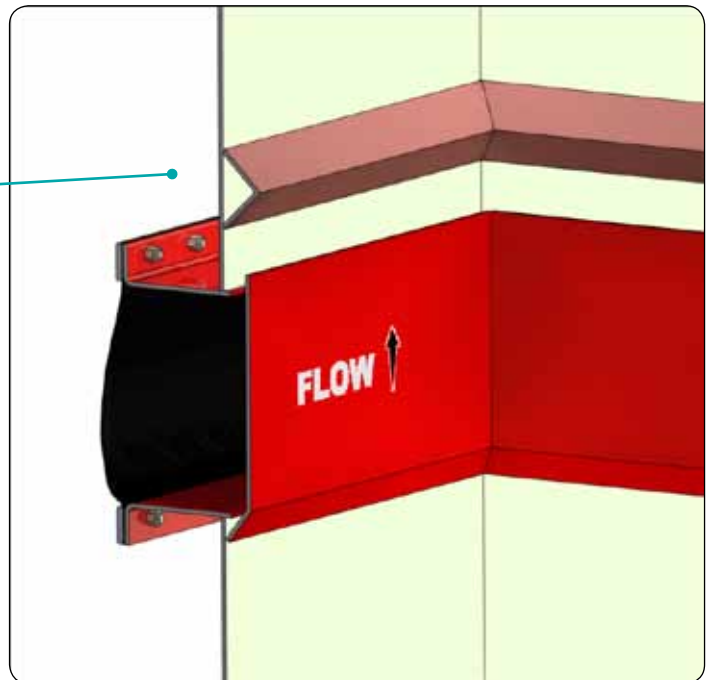



## FLEXXCEL FLUOROPLASTIC MATERIALS



U.S. Bellows offers a variety of Fluoroplastic materials.

## FLEXXCEL FLUOROPLASTIC MATERIALS

Fabric belt material selection is a critical factor in the successful design of each fabric expansion joint. A number of materials are widely accepted for use in fabric expansion joint applications. These materials fall into two general families:

**Fluoroplastics (PTFE)**—Also known commercially as PTFE 25% Glass Filled. The chemical resistance of this material is unequalled by other materials.

**Elastomers**— A general name for the group of synthetic “rubber” materials that are characterized by their elastic property. These materials are also known by their commercial names as Viton®, Hypalon®, EPDM, and Chlorobutyl.

Chemical resistance, temperature limitations, abrasion resistance, tensile strength and susceptibility to flutter/vibration are major considerations when selecting a fabric material. Please review the following section for details regarding FLEXXCEL Fluoroplastic products.



Silica Oxide Glass Cloth

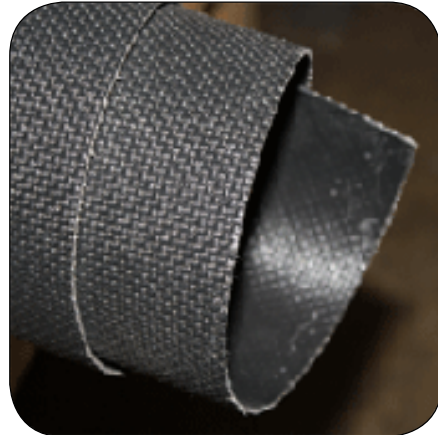

PTFE Coated Glass Cloth



Reinforced Silicone Fabric

## EVOLUTION OF FLEXXCEL FLUOROPLASTIC MATERIALS

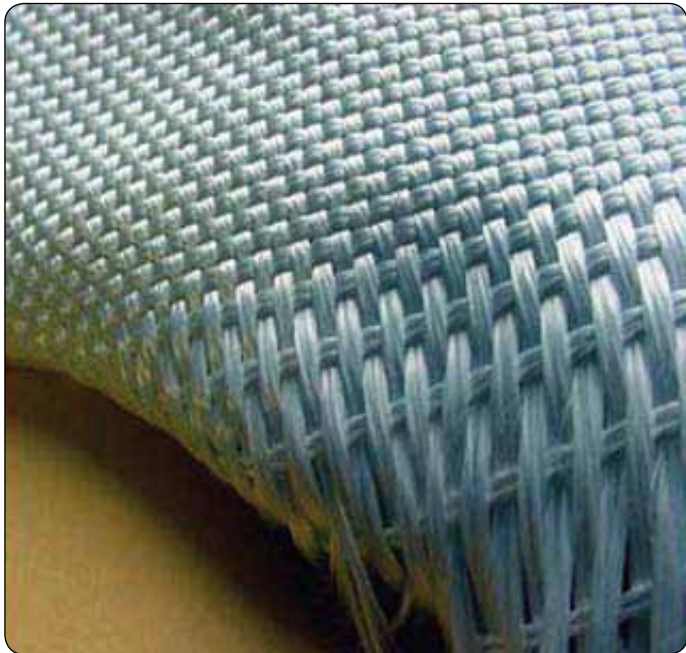

Fiberglass reinforcement filaments are E grade or better providing excellent tensile strength.



- Fiberglass substrate is thoroughly coated on both sides with a minimum of 35% to 40% by weight of PTFE resin for mechanical strength.
- Fluoroplastic coating is 100% pure PTFE material.

### Fiberglass Coating Process

Fiberglass + PTFE = Coated Fiberglass

Coated Fiberglass



Thin PTFE Film



+

=

Magnified Fabric Cross Section



PTFE Film

Coated Fiberglass

Extruded, thin single ply film laminated to coated fiberglass.

- All FLEXXCEL materials have a chemical barrier film to protect the fiberglass substrate and minimize porosity. The chemical barrier component of these materials is in the form of a film that is laminated to the fiberglass cloth.

### FLEXXCEL MD4 and HD4 = FOR DRY SERVICE

Coated Fiberglass



+

LFP™ Cross Film

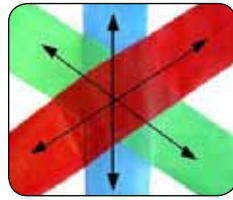

=

Magnified Fabric Cross Section

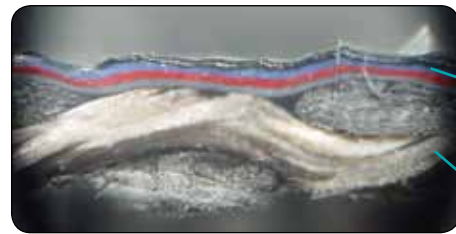

Multi-layered  
LFP™ Cross Film  
Coated  
Fiberglass

LFP™ CrossFilm based chemical barriers are laminated to the coated fiberglass. The use of LFP™ CrossFilm Chemical Barriers provides superior protection in corrosive environments.

**FLEXXCEL MD7, HD7, HD12,  
and HD20  
= FOR WET SERVICE**

A zero porosity chemical barrier is the most critical component for preventing chemical attack.



Coated Fiberglass with Film



+

Insulation Mat



=

FLEXXCEL HT



Coated  
Fiberglass  
with Film  
Insulation  
Mat

- FLEXXCEL HT series fabric belts rated for temperatures up to 1000°F. Insulation is bonded to FLEXXCEL HD4 material to prevent hot gas from residing between the two components.
- Extends life of insulation component.
- Prevents insulation from falling into duct.
- Makes installation of high temperature composite belts easier.

**FLEXXCEL HT1, HT3, and HT5  
= FOR HOT-DRY SERVICE**







## FLEXXCEL FLUOROPLASTIC BELT MATERIALS

Fluoroplastic materials have been successfully used in challenging expansion joint applications since the early 1980s. The expansion joint fabric is composed of two components— PTFE resins and fiberglass cloth. The fiberglass is used to give the fabric strength. The fiberglass can be of varying weights to give the fabric material the necessary tensile strength. The fiberglass alone is susceptible to degradation from chemicals and liquids. By thoroughly coating all surfaces of the fiberglass filaments, a strong and flexible base material is created. This base material can then be laminated to a PTFE film (Chemical Barrier) of varying thickness to provide a nonporous and chemically inert gas seal. Its virtual inertness to most chemicals make it an excellent choice for applications in wet corrosive environments.

Fluoroplastics also retain their structural integrity at extremely high or low temperatures, i.e., 600°F to -110°F (uninsulated). Fluoroplastics are capable of withstanding temperatures in excess of 1500 degrees F when properly insulated (composite belt).

### Features of Fluoroplastics

- High strength to weight ratio. Easier to handle and install compared to Elastomers.
- Simple splice and repair by means of heat seal iron. Material does not age like Elastomers and therefore can be repaired for the life of the material.
- Temperature capability up to 600°F without additional insulation.
- Materials are easy to drill and punch.

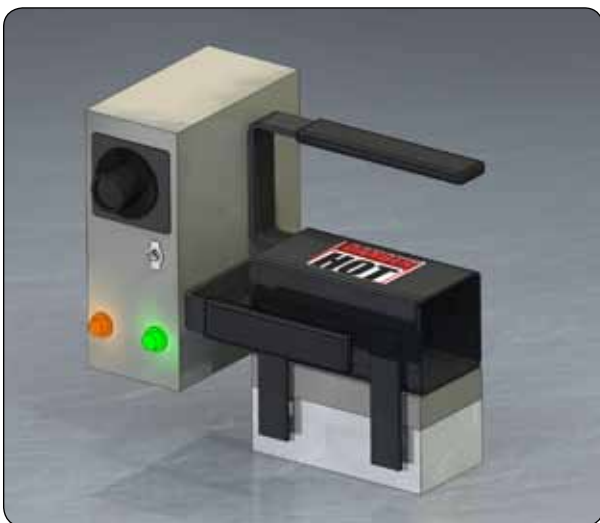

## GUIDE TO SELECTING A FLUOROPLASTIC BELT MATERIAL

Compare the maximum continuous operating temperature of the application against the fabric temperature rating.

If the application has high fly ash or dust loading, select a material with high tensile strength. (Fluoroplastic materials are susceptible to failure from abrasion. In applications where the media includes particulate, a liner must be present.)

If the application is near a fan or anywhere flow turbulence is expected, select a material with high flutter resistance.

In areas of scrubbers or applications that experience condensation of low temperature gases, select a material for wet service.

For areas where corrosion is most severe, we recommend FLEXXCEL HC40.

Material Name	Temp. (°F)	Service	Tensile Strength	Chemical Barrier Thickness	Flutter Resistance	Relative Cost
FLEXXCEL MD4	600	Dry	Medium	4 mil	Low	\$
FLEXXCEL HD4	600	Dry	High	4 mil	Low	\$
FLEXXCEL MD7	600	Wet	Medium	9 mil	Low	\$\$
FLEXXCEL HD7	600	Wet	High	9 mil	Low	\$\$
FLEXXCEL HD12	600	Wet	High	12 mil	Low	\$\$\$
FLEXXCEL HD20	600	Wet	High	20 mil	Medium	\$\$\$\$
FLEXXCEL HC40	500	Wet	Medium	40 mil	Medium	\$\$\$\$\$
FLEXXCEL FF1	600	Wet	Very High	9 mil	Very High	\$\$\$\$\$
FLEXXCEL DP1	600	Wet	High	20 mil	High	\$\$\$\$
FLEXXCEL HT1	700	Dry	High	6 mil	High	\$\$\$
FLEXXCEL HT3	850	Dry	High	6 mil	High	\$\$\$
FLEXXCEL HT5	1000	Dry	High	6 mil	High	\$\$\$



13" x 5" Rectangular Fabric Expansion Joint

## FLEXXCEL FLUOROPLASTIC APPLICATION SPECIFIC MATERIALS

### FLEXXCEL HC40 For Highly Corrosive Applications

Thin PTFE Films\*

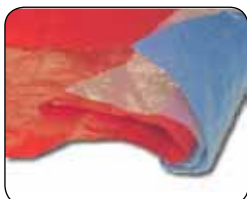

Multi-Directional Stackup

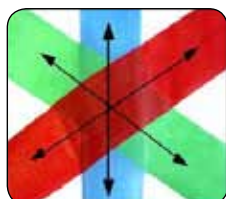

Finished Product



\*Colors used to differentiate layers

- LFP™ is an all PTFE material that is flexible, resists tearing and has superior flexing capabilities compared to other PTFE products.
- Because this is an all PTFE product with excellent mechanical capability, no compromising reinforcement that can be chemically attacked is needed.
- Regardless of the chemical exposure, LFP™ eliminates concern for chemical attack. This has been proven in laboratory and industrial service where, in all cases and regardless of chemical environment, LFP™ has retained all of its physical properties.



### FLEXXCEL FF1 For Flutter Applications



- Engineered for turbulent flue gas conditions, FLEXXCEL FF1 is manufactured to a high weight without sacrificing the critical flexing properties require for a fabric expansion joint. Because of the high weight, it doesn't move during operation except to flex due to thermal movements.
- Constructed of 7 plies of Fluoroplastic and fiberglass insulation that are thermally welded together on regular intervals.



### FLEXXCEL HT Composite Belt

Engineered for applications above 1000°F, HT Composite Belts combine FLEXXCEL HT5 gas seal with an additional layer of fiberglass insulation and reinforced with a layer of cloth and wire mesh. The edges are held together with fiberglass cuffs that also serve as high temp gaskets.

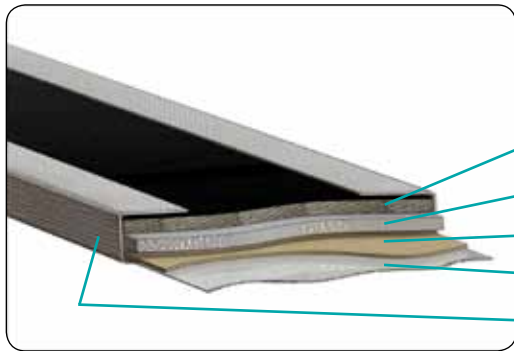

- FLEXXCEL HT5
- Fiberglass Insulation
- Aluminized Fiberglass Cloth
- Wire Mesh
- Fiberglass Cuff



### FLEXXCEL DP1 Dew Point Belt

In flue gas ducts operating at or near dew point, a single ply fabric belt can present a cold surface for corrosive condensation to occur. In order to minimize heat loss at the belt and still allow access for inspection and replacement, a special belt construction — FLEXXCEL DP1 can be specified. The inner gas seal has a thick chemical barrier and the outer component has an integral layer of insulation. This belt construction reduces potential chemical attack to the ducting and expansion joint frame.

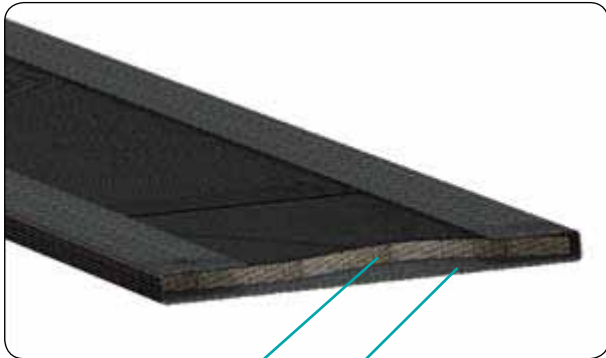

- FLEXXCEL HT5
- Gas Seal with Chemical Barrier





## FABRIC EXPANSION JOINT MATERIALS COMPARISON CHART

Temperature	Materials	Advantages	Pressure	Chemical Resistance	Applications
Low Ambient - 250 °F	<ul style="list-style-type: none"> <li>Butyl Rubber</li> <li>Neoprene</li> <li>Viton™</li> </ul>	<ul style="list-style-type: none"> <li>High tensile strength</li> <li>Ozone and weathering resistance</li> </ul>	Medium	High	<ul style="list-style-type: none"> <li>Hot and Cold Water</li> <li>Low Pressure Steam</li> <li>Neutral Solutions</li> </ul>
Medium 250 - 250°F	<ul style="list-style-type: none"> <li>Fiberglass</li> <li>Reinforced Silicone</li> </ul>	<ul style="list-style-type: none"> <li>Resistant to deterioration by weathering and engine oil remains</li> </ul>	Low	High	<ul style="list-style-type: none"> <li>Gaskets or Seals</li> <li>Recirculation Air</li> <li>Air Intake</li> </ul>
High 500 - 700°F	<ul style="list-style-type: none"> <li>PTFE Impregnated Fiberglass</li> <li>PTFE Coated Glass Cloth</li> </ul>	<ul style="list-style-type: none"> <li>High tear/crease resistant</li> <li>Smooth, low friction, non-stick surface, high tensile strength</li> </ul>	Low	Medium	<ul style="list-style-type: none"> <li>Exhaust Ventilation</li> <li>Fume Protection</li> <li>Gaskets or Seals</li> </ul>
High 700 - 1000°F	<ul style="list-style-type: none"> <li>Silica Fabric Cloth</li> </ul>	<ul style="list-style-type: none"> <li>High abrasion resistance</li> <li>Won't rot or mildew</li> </ul>	Low	Low	<ul style="list-style-type: none"> <li>Boiler Exhaust</li> </ul>
High 1000 - 1800°F *3-Layer	<ul style="list-style-type: none"> <li>Silica/PTFE Fabric Kaowool</li> <li>Aluminized Glass Cloth with Kaowool &amp; PTFE</li> </ul>	<ul style="list-style-type: none"> <li>Excellent resistance to chemicals</li> <li>High temperature stability</li> </ul>	Low	Low	<ul style="list-style-type: none"> <li>Furnaces</li> <li>Kilns</li> </ul>



Reinforced Silicon Fabric



PTFE Coated Glass Cloth

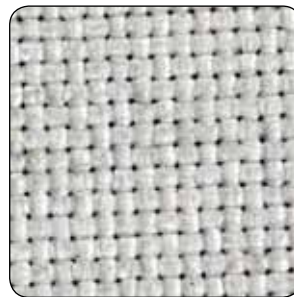

Aluminized Glass Cloth

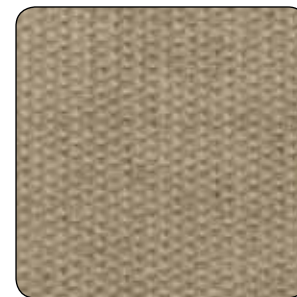

Silica Oxide Glass Cloth

## FLEXXCEL ELASTOMERIC MATERIALS

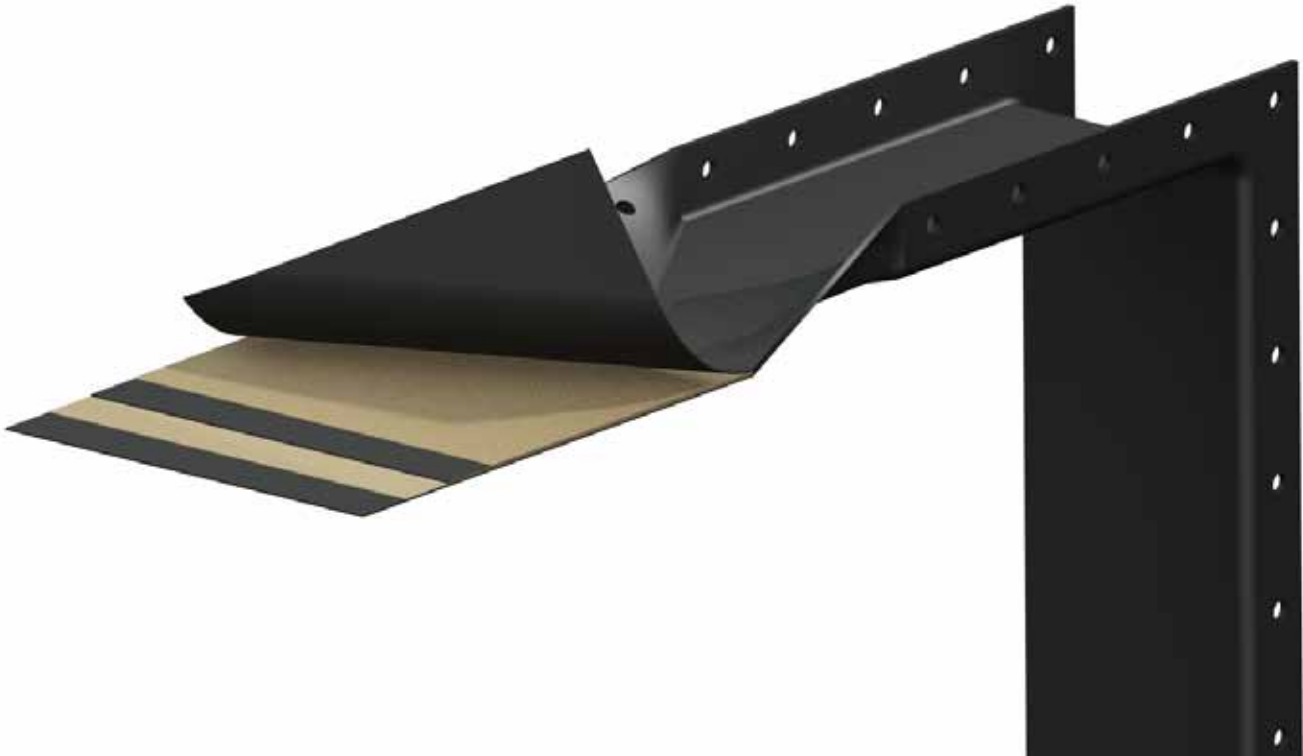

U.S. Bellows offers a variety of Fluoroelastomer materials.

## FLEXXCEL ELASTOMERIC MATERIALS

Before the development of Fluoroplastics, a group of synthetic “rubber” materials were commonly used in flue duct expansion joint applications. These materials, known as Elastomers, include Viton™, EPDM, Chlorobutyl, Hypalon™ and others.

Because of their elastic properties, the various Elastomers are built up into a multi-layered sheet reinforced with fiberglass or Aramid fabric. The finished product, 1/8" to 1/4" thick, is then used as a flat belt or as an integrally flanged U-shaped cross section that bolts directly to duct or equipment flanges. The inherent characteristics of flexibility, abrasion resistance, and flutter resistance translates to long service life when applied properly.

Fluoroelastomer, also known as FKM or by its commercial name Viton™, is the most commonly used Elastomer in flue duct joints. It is a high performance material that resists acids and many other chemicals.

Please review the following section for details regarding FLEXXCEL Fluoroelastomer and Elastomer products.



Aluminized Glass Cloth

## FLEXXCEL ELASTOMERIC BELT MATERIALS

Though Elastomers have been used successfully in many applications since the 1960s, they have some limitations and drawbacks. The biggest limitation is the relatively low temperature capability (see table on pg. 57). Compared to Fluoroplastics, they are heavy and as a result more difficult to install. Splicing Fluoroelastomer material requires vulcanization -- a curing process that involves high heat, pressure and the addition of sulfur as a curative. Splicing and repair is limited after the material ages. Fluoroelastomers are also less resistant to chemical attack than Fluoroplastics.

See the table on pg. 57 for the full line of Elastomeric materials that U.S. Bellows offers.

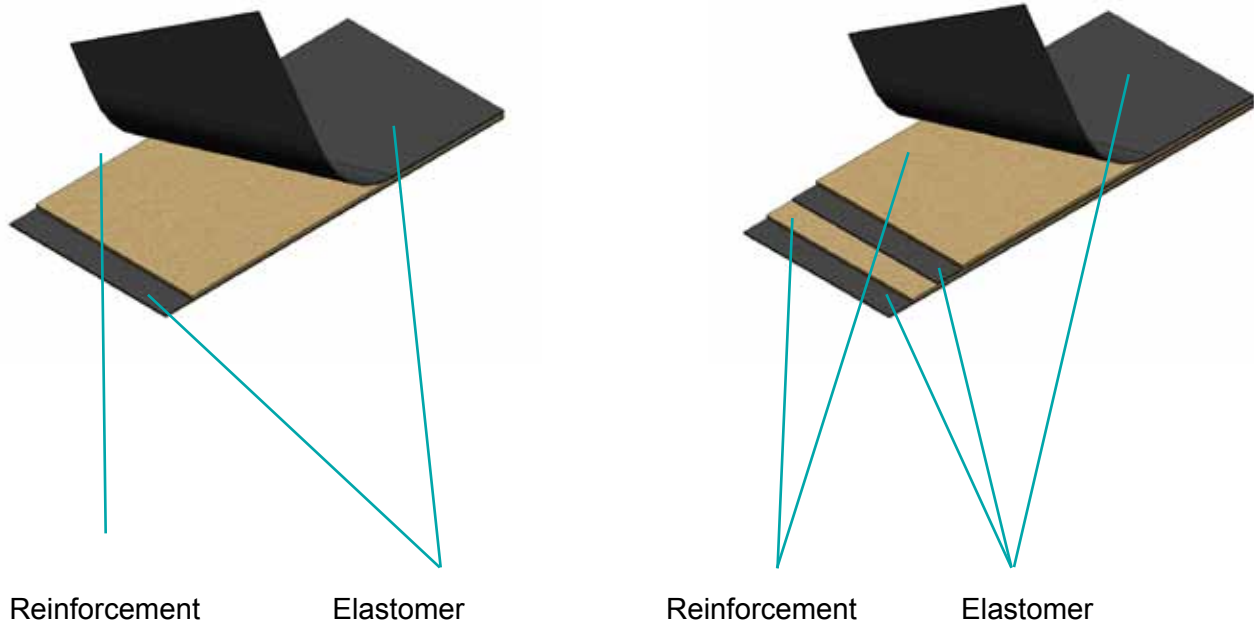

## GUIDE TO SELECTING AN ELASTOMERIC BELT MATERIAL

1. Compare the maximum continuous operating temperature of the application against the fabric temperature rating.
2. If the application has high fly ash or dust loading, select a material with high tensile strength.
3. If the application is near a fan or where flow turbulence is expected, select a material with high flutter resistance.
4. Elastomers vary in their chemical resistance. The selected Elastomer should be checked to insure that it is compatible with the particular media it will encounter.

Material Name	Elastomer	Temp. (°F)	Service	Tensile Strength	Flutter Resistance	Relative Cost
FLEXXCEL RH125	Hypalon™	225	Dry	Medium	Medium	\$
FLEXXCEL RE125	EPDM	300	Wet*	Medium	Medium	\$\$
FLEXXCEL RE25	EPDM	300	Wet*	High	High	\$\$\$
FLEXXCEL RC125	Chlorobutyl	300	Dry	Medium	Medium	\$\$
FLEXXCEL RC25	Chlorobutyl	300	Dry	High	High	\$\$\$
FLEXXCEL RVF25	Fluoroelastomer	400	Wet	Medium	Medium	\$\$\$\$\$
FLEXXCEL RVF25	Fluoroelastomer	400	Wet	High	High	\$\$\$\$\$\$\$\$
FLEXXCEL RVF25M	Fluoroelastomer	400	Wet	High	High	\$\$\$\$\$\$\$\$\$\$

\* Not suitable for sustained service where oils, hydrocarbons or concentrated mineral acids are present.



Round Fabric Expansion Joint



## FLEXXCEL FABRIC EXPANSION JOINT INSTALLATION AND SPLICING INSTRUCTIONS

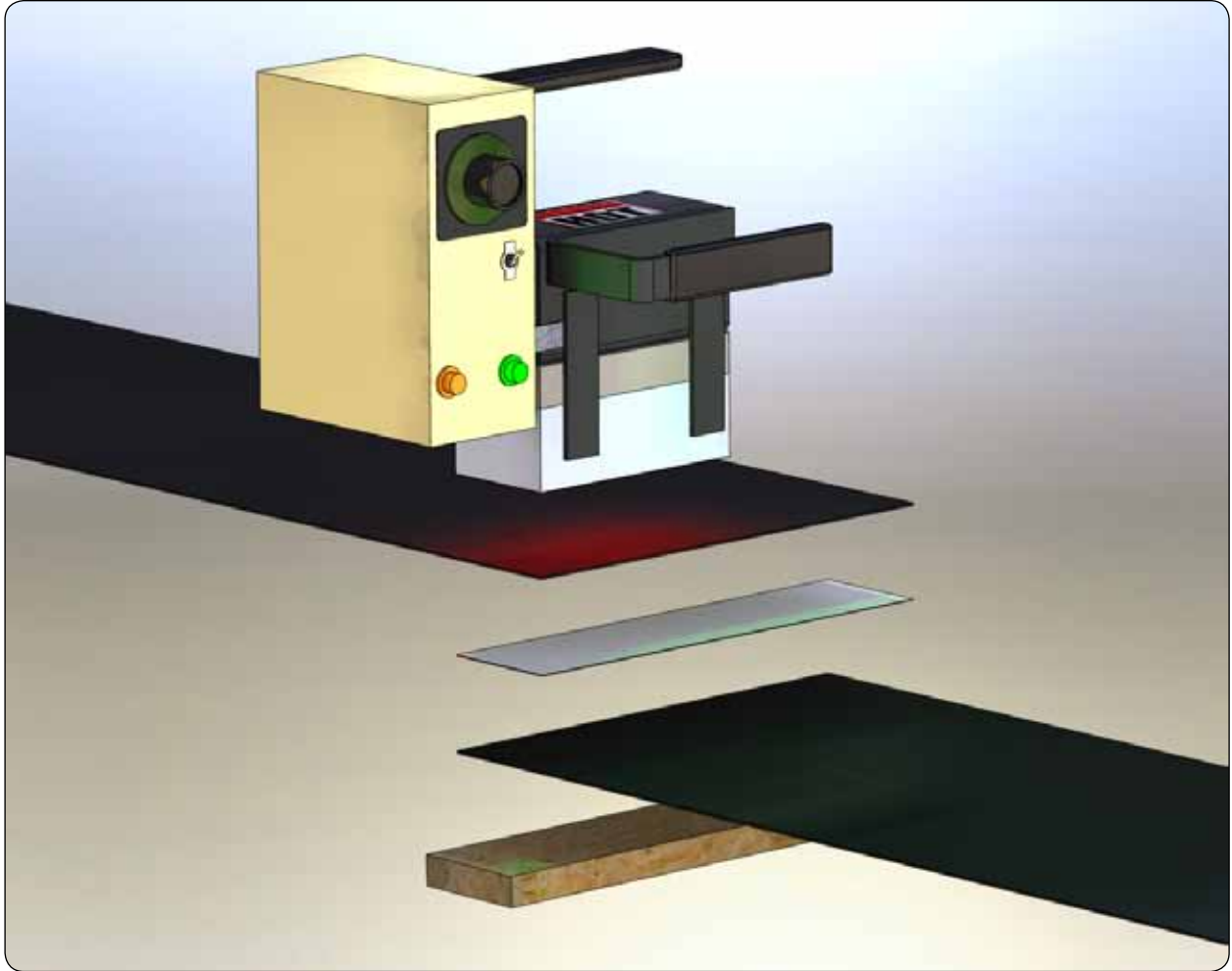

Please visit [www.usbellows.com/install-fabric](http://www.usbellows.com/install-fabric) for installation instructions.



## Shipping and Installation of Fabric Expansion Joints

Fabric expansion joints can be shipped in a variety of conditions to allow for the most economical installation. In certain instances, it is practical to ship joints fully assembled ready to drop into place. In other cases where access is limited or joint size exceeds normal shipping constraints, the joint can be provided broken down into small segments and then assembled in place at the job site. The fabric belt itself may require field splicing which is accomplished with a heat seal iron and splice kit.

U.S. Bellows will provide the appropriate detailed storage, handling, and installation instruction based on how the expansion joint is shipped.

The following section provides an overview of instructions that are available.

## FLEXXCEL INSTALLATION INSTRUCTIONS

Applicable installation instructions will accompany each expansion joint or fabric belt shipped by U.S. Bellows. These instructions provide clear step by step procedures as outlined on the following pages.

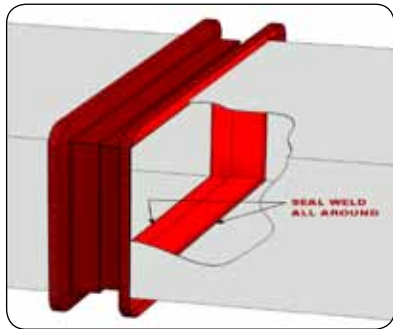

Seal Weld Frames

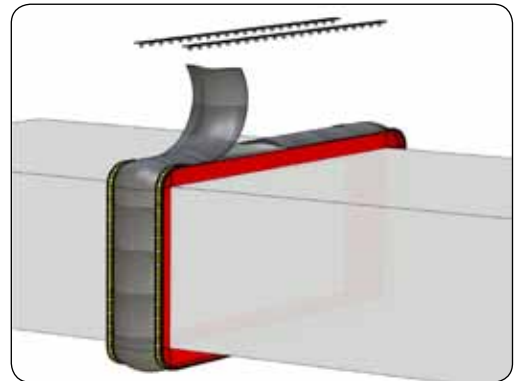

Align Bolts to Fabric

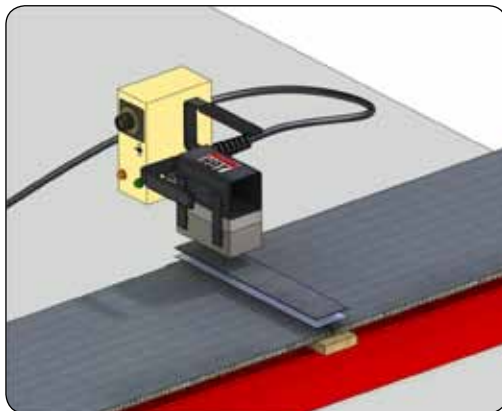

Belt Splice

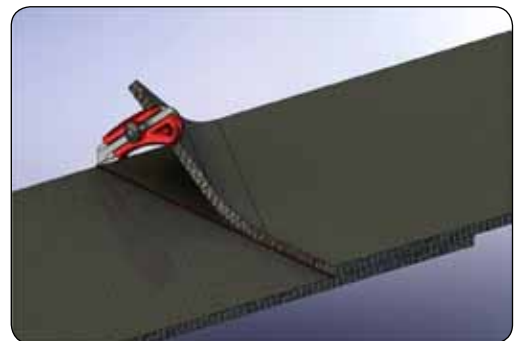

Trim FLEXXCEL HT Belt Material

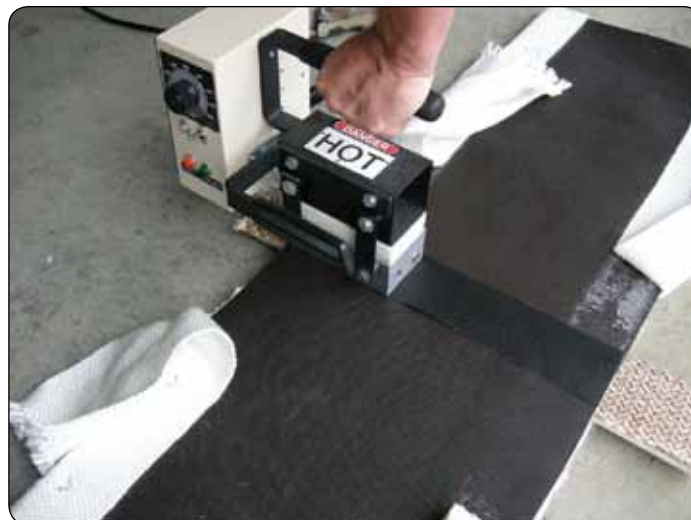

Belt Splice

## ASSEMBLED AND UNASSEMBLED FRAME INSTALLATION

### Factory Assembled

Where conditions allow, fabric expansion joints can be shipped factory assembled ready to install. The complete joint can be lifted in place with a crane and attached, either by welding or bolting, to ducting or equipment.

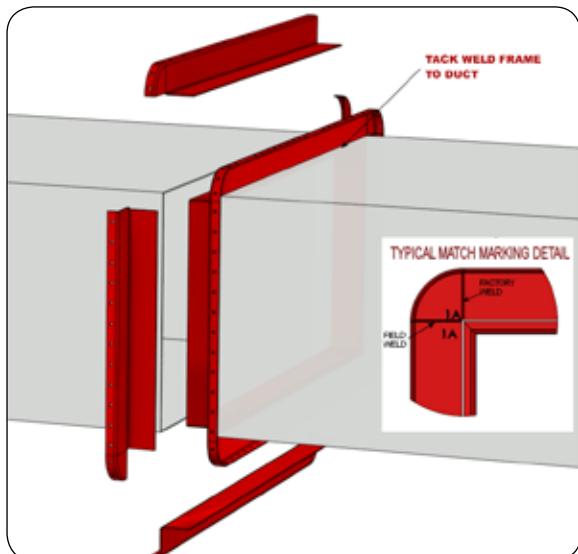
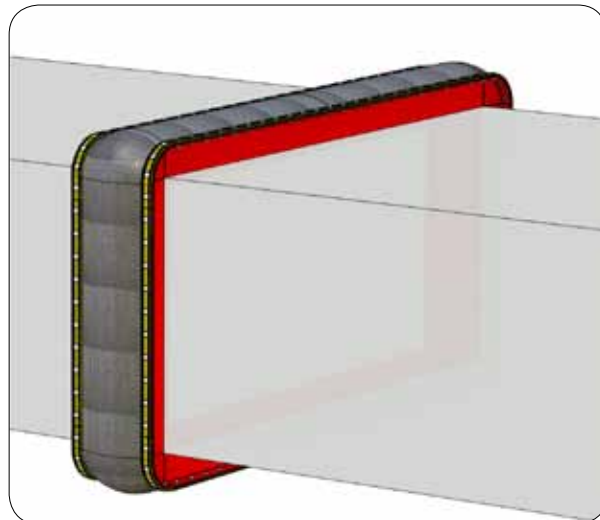
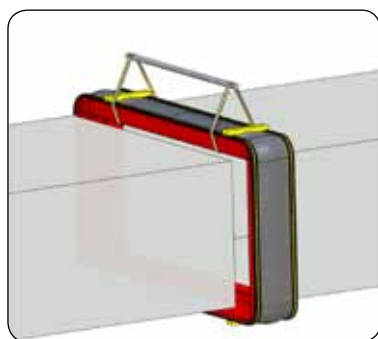

### Unassembled

In some instances, it may be preferable to purchase the expansion joint unassembled and complete the assembly of the joint in place on the ducting. In these cases, the frame will typically ship as rails attached to corners for rectangular joints and in c-sections for round joints. The fluoroplastic fabric belt is easy to field drill and splice in place.

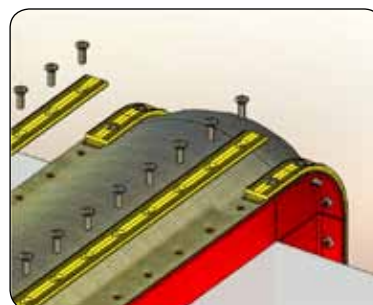



## FLUOROPLASTIC BELT SPLICE

### FLEXXCEL Heat Seal Iron

Fluoroplastic fabric gas seal elements often require field splicing during installation and replacement. Cost effective and easy-to-use heat seal irons are available from U.S. Bellows for purchase or rent.

FLEXXCEL Fluoroplastic fabric gas seal elements are repairable for the life of the material using the heat seal iron.



### Single Ply Belt Splice







## HIGH TEMPERATURE FLUOROPLASTIC BELT SPLICE

**HT Belt Saddle Splice**

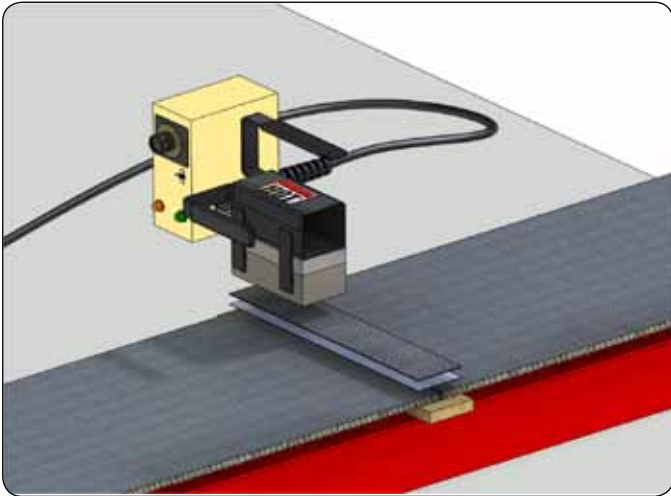

**HT Composite Belt Splice**



## INSTALLATION KITS

**Sewing Kit**



**Silicone Kit**



## ENSUREASPLICE TEST SPLICE

Splicing of fabric expansion joints is a critical operation which needs to be performed correctly for the expansion joint splice to hold up under system operating conditions. U.S. Bellows' ensureAsplice is the answer to assure that a splice is made correctly. U.S. Bellows ensureAsplice material is a thin, flexible, lightweight, PTFE material that clearly indicates when the proper conditions have been established for achieving a successful test splice on FLEXXCEL Fabric Expansion

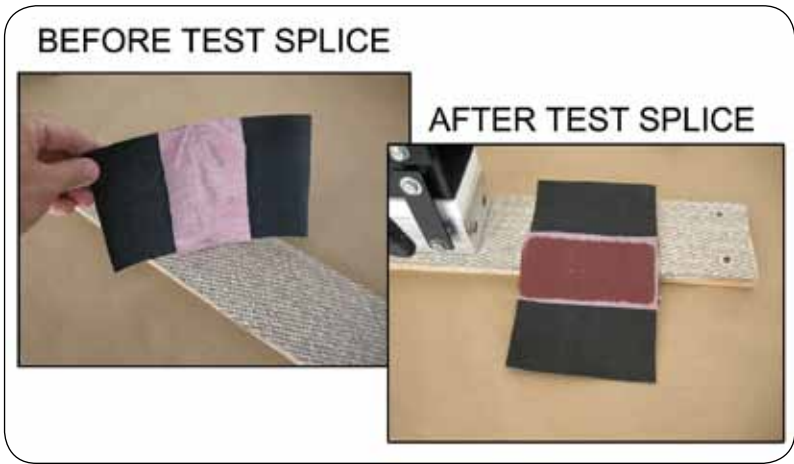

Joint materials. The U.S. Bellows ensureAsplice material accomplishes this in two ways. First, a dramatic color change in the product during the splicing procedure ensures that the critical sealing temperature has been reached in the splice area. In addition, the material bonds to the expansion joint's PTFE surface, confirming that sufficient pressure was applied during the splicing operation.



The U.S Bellows ensureAsplice product changes from a light shade of red to a much darker shade of the red. The easily observed color change can only take place after the splice components have reached the critical sealing temperature required for PTFE products. If sufficient pressure has been applied as the color change occurs, the product will adhere to the expansion joint's PTFE surface, confirming that the proper splicing conditions were achieved.

An after test splice inspection (picture shown above), reveals delaminated material, ensuring a successful splice was achieved.

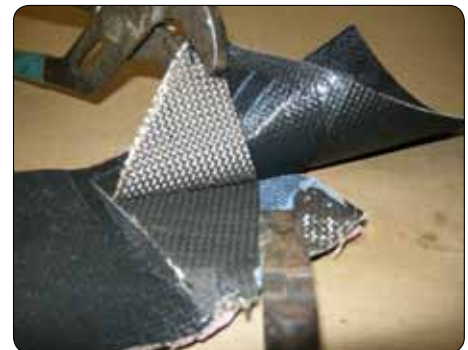

## PROPERLY INSTALLED EXTERNAL INSULATION

Do not insulate over the fabric expansion joint unless specified by the U.S. Bellows drawing (see below for acceptable duct insulation design). In general, the external insulation should allow access to the belt for inspection and replacement. In high temperature applications, insulation should be designed to allow thermal convection in the area of the belt attachment. In applications where the temperature is near the dew point of the gas, the design should minimize cold spots which could lead to corrosion.

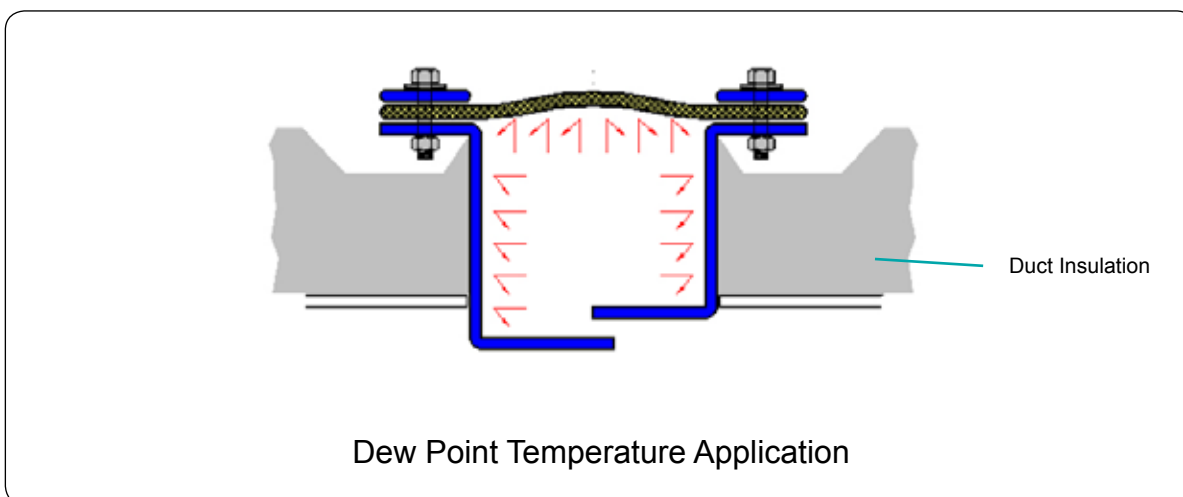
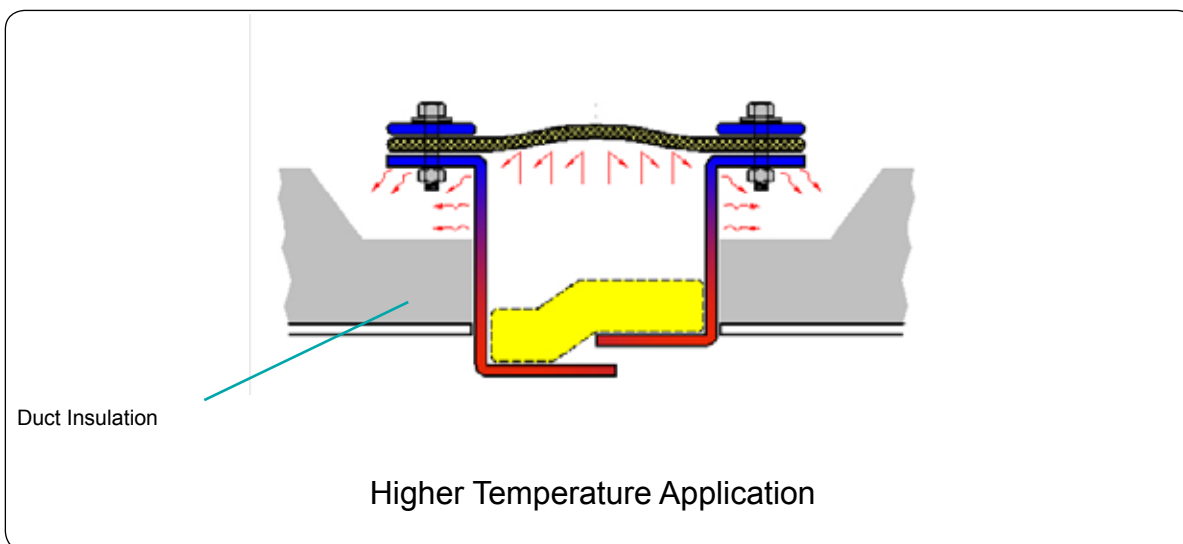
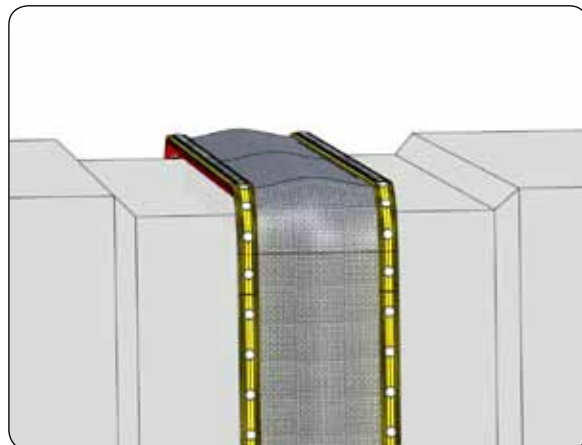

## PRODUCT SHOWCASE

### Single Flanged Expansion Joint for an Exhaust Duct Application

The single flanged metallic expansion joint was manufactured from 304 stainless steel bellows with carbon steel flanges. It has a diameter of 20" and an overall length of 15". It will be used in an exhaust duct application in a power plant. A hydro-test was performed prior to shipping to Orlando, Florida.

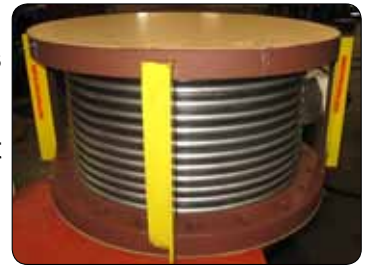

### 76" Diameter Single Expansion Joints with Refractory Lining

U.S. Bellows, Inc. fabricated several expansion joints composed of 321 stainless steel and A588-A Corten angle flanges. The expansion joints measure 76" in diameter and have an overall length of 27<sup>3</sup>/<sub>4</sub>". Each expansion joint is also lined with 4" thick refractory

lining. The bellows long seams were 100% x-rayed and dye-penetrant tested. The bellows will be used in flue gas service associated with a clean fuels project at an oil refinery.



### Same Day Turn Around Service: 8" Single Expansion Joint for an Emergency Shutdown

U.S. Bellows, Inc. received this single expansion joint in the morning, refurbished it by adding new bellows and limit rods, and then shipped it the very same day. The existing expansion joint had 321 stainless steel bellows with 1,500 lb. flange on one side and 150 lb. flange on the other side. U.S. Bellows, Inc. manufactured 321 new stainless steel bellows and reused the existing flanges by sandblasting and then painting them for protection. Same day delivery enabled the customer to resume operations with minimum loss of time and production.



### 18" Single Expansion Joints for an Offshore Oil Platform in Korea

These expansion joints measure 18" in diameter x 11" in overall length. Each expansion joint is fabricated with 300 lb. stainless steel raised face slip on flanges. The liner, cover, and tie-rods are fabricated from 316L stainless steel. The design pressure is 403 psi, and the design temperature is 200°F. Dye-penetrant tests, hydro-tests at 604 PSIG, and 100% x-ray tests of the bellows' longitudinal weld seams were performed to assure quality.





## PRODUCT SHOWCASE

### Single Tied Metallic Expansion Joints with Two-Ply Alloy Bellows

This single tied metallic expansion joint was designed with two-ply alloy bellows for a design pressure of 243 PSIG at 108°F. The expansion joint has an axial compression of 0.020" and a lateral movement of 0.200". The axial spring rate is 13,320 lb./in. and the lateral spring rate is 121,202 lb./in. The bellows and flanges were 100% x-ray tested and the bellows were 100% dye-penetrant tested for quality before being shipped to the customer.



### Flanged Expansion Joints for a Thermal Power Plant

These 6" and 8" in diameter flanged expansion joints were shipped to the customer a month ahead of schedule. The bellows are stock 321 stainless steel and the flanges are 150 carbon steel. They can take 1.22" axial deflection, plus or minus 0.26 lateral deflection and are designed to handle temperatures ranging from -24°F to 800°F. These expansion joints are rated up to 150 PSI and come equipped with an internal flow liner to allow for smooth fluid flow. They were 100% dye-penetrant tested and air & soap bubble tested to ensure quality.

### 18" Expansion Joints that Required Helium Leak Testing

This order required custom engineering to design and manufacture these expansion joints due to their critical service condition requirements. U.S. Bellows manufactured and tested these expansion joints to the customer specifications, EJMA Standards and U.S. Bellows Quality Standards. The expansion joints were designed for a pressure of 176 PSIG at 500°F. The axial extension is .5 and the axial compression is 1.5. The 18" expansion joints were fabricated from 304 stainless steel with specially designed and machined flange faces with a gasket groove. Each expansion joint was helium leak tested and 100% x-rayed and dye-penetrant examined.



### 5 Expansion Joints for a Heat Exchanger Company in Japan

These expansion joints were fabricated from ASTM-A-240 Type 321 stainless steel bellows and liners. The shell material is ASTM-A-516 Grade 70. They are 32" diameter with an overall length of 26". Each joint weighs 280 lb. They were designed for 150 PSIG at 650°F with a travel capacity of 0.33 axial compression and 0.08 lateral deflection. These expansion joints absorb differential expansion between the shell side and tube side of a heat exchanger. They were hydrostatically tested to 208 PSIG to comply with the Japanese code, Ministry of Health, Labor and Welfares (MHLW) and the ASME Pressure Vessel Codes.



## PRODUCT SHOWCASE



### Single Expansion Joint Assembly for an Oil Refinery in South Africa

This single expansion joint assembly was fabricated with a single-ply 304 stainless steel bellows, carbon steel pipe, miter bends, and limit rods. It measured 12 feet 2 inches from the center to center of the elbows. These bellows were designed with a low spring rate to meet the allowable forces and movements on the compressor inlet nozzle. All welds were air tested and spot x-rayed to assure quality and performance. This unit was completed in 3 weeks to meet the customer's construction schedule.

### 188 Single Tied Expansion Joints for a Construction Company

These products are single tied expansion joints with 150 lb. flange drilling. They were fabricated completely of 316 stainless steel. They range in size 6" to 18" in diameter and weigh between 40 lb. to 140 lb. each. Their travel capacity ranges from 0.88" to 1.2" at 25 PSIG and 180°F. The expansion joints are used in a water treatment piping system facility. The bellows longitudinal and attachment weld seams were 100% dye-penetrant examined. The expansion joints were pneumatically tested at 15 PSIG for performance and quality assurance.



### 14 Single Reinforced Metal Expansion Joints

These single reinforced expansion joints with equalizing rings are used in heat exchangers. The bellows are fabricated from ASTM B 443 Inconel® 625 LCF. The weld ends and the reinforcing rings/root rings are carbon steel. The expansion joints are 52" and 57" diameter with an overall length of 15 ½" and 16 ½". They are capable of moving 0.6" in extension at 158 PSIG at 300°F. The expansion joints were fabricated to ASME Section VIII. The bellows and pipe longitudinal weld seams were 100% x-rayed. In addition, they were 100% dye-penetrant examined and hydrotested to 205 PSIG for quality and performance assurance.

### 4 Convolution Expansion Joints for an Oil Company in India

This high pressure expansion joint is a single four convolution SB-443 INCO 625LCF bellow with 3 equalizing rings, 2 neck bands, 1 internal liner and 2 weld ends all fabricated from SA-240 type 347 stainless steel. The equalizing rings enable the joint to withstand a maximum allowable pressure of 1,170 PSIG at 815°F. The equalizing rings allow the use of a thinner more compact and flexible bellow thereby saving space and increasing the expansion joint cycle life. This expansion joint is 14.25" long with a calculated cycle life of 772 cycles.



## PRODUCT SHOWCASE



### Single Tied Expansion Joints for an Oil Refinery

This single tied expansion joint was designed to withstand 400 PSIG and 200°F. The bellow was manufactured using B443 material (Inconel® 625) with a 300 lb. carbon steel flange. It measures 8" x 16" with 3/16" lateral movement. Pressure testing and 100% dye-penetrant tests were performed to ensure quality. The final product was shipped to a customer in Bakersfield, California.

### Immediate Refurbishment of a 3" O.A.L. Single Bellows

U.S. Bellows, Inc. recently refurbished a 3" O.A.L. single bellows with flanges for a marine vessel in Texas. Within a two day span, the replacement bellows was fabricated, welded to the existing 5/8" flanges, and shipped to the marine vessel to resume operation. The replacement bellows, fabricated from 321 stainless steel, is designed for 150 PSIG and 800°F with 0.66" of axial movement. To ensure quality, a 100% dye-penetrant test and a soap leak test were performed prior to delivery.



### Clamshell Bellows for a Shell and Tube Heat Exchanger

This clam shell bellows was fabricated for a shell and tube heat exchanger. The clam shell bellows is designed and fabricated per ASME VIII Div. 1 appendix 26. It has a 14" diameter and was designed at 150°F and 150 PSIG. In order to detect any leaks, prior to and following forming, the heat exchanger and its welds were subjected to a series of tests such as the dye-penetrant test (100%), x-ray test (100%) and air test.

### Three-day Emergency Fabrication of a 40" I.D. Expansion Joint

Within a three day span, this 40" I.D., single coded, clamshell expansion joint was fabricated for a chemical plant in Beaumont, Texas. After the representative from the chemical plant completed the online form, the U.S Bellows' on-call team was immediately paged. Three days later the bellows had been successfully fabricated, welded to an A516-70 heat exchanger shell and shipped to the chemical plant to resume operation. The bellows was fabricated from A240 tp 321SS and designed at 50 PSIG and 750°F. In order to detect any leaks in the weld, the bellow's long seam weld was 100% x-rayed and its attachment weld was 100% dye-penetrant tested.



## PRODUCT SHOWCASE

### 10" Single Tied Titanium Expansion Joints

These 10" single tied titanium expansion joints were manufactured to be utilized in a chemical plant in Kingsport, Tennessee. These single expansion joints are bellows elements with end connections that allow movement in any direction or plane. However, the piping must also be guided in the same direction of the movement. The tie rods restrain the full pressure thrust. These expansion joints were 100% dye-penetrant examined before being shipped to the customer.



### Emergency Order for a 48" Diameter Expansion Joint

U.S. Bellows, Inc. rushed to an emergency call of an Alaskan petroleum firm. The firm called upon U.S. Bellows' 24 x 7 Quick-Turn/Emergency service to aid them in the immediate replacement of a defective, 48" diameter expansion joint when their G417 Pump failed suddenly during the plant startup. U.S. Bellows received the emergency call on Friday at 5:30 p.m. On Saturday, the 48" diameter expansion joint was built and shipped to the location on the same day. On Sunday, the expansion joint was installed at the customer's location.

### A Custom Spring Support Was Designed Using a Metal Bellows Instead of a Spring Coil

A custom spring support was designed using a metal bellows instead of a spring coil. The bellows was fabricated from stainless steel, because it will be used in a highly corrosive, off-shore environment. By utilizing the metallic bellows, it was much easier to customize for a short run production, produce variations of spring rate, and develop a high load-carrying capacity. An added benefit of using the bellows instead of a custom coil was that it reduced fabrication time by half. The rolled plate shown on the left is welded to the structural pipe on the platform and a riser clamp was attached on the right.



### 76" Diameter Single Tied Expansion Joint for a Hot Blast Valve in a Steel Mill



This single tied expansion joint is custom designed with Inconel® 825 bellows with carbon steel flanges, liners and pipes. It is 76" I.D., 90" O.D. and is 31-1/2" long. It was designed for 1,900°F at 100 PSIG with 1" compression. A meshed expanded metal cover was installed to allow for hot air to escape. Tests performed included a 100% dye-penetrant, x-ray, and ultrasonic on pressure bearing welds. Finished units were hydro-tested at 1.5 times the design pressure. The expansion joints were designed with an inner liner to accommodate for easier field installation of refractory lining.



## PRODUCT SHOWCASE

### Single Expansion Joint For A Heat Exchanger

This 48-3/4" diameter single metallic expansion joint will be used in a heat exchanger. The bellows are 321 stainless steel and the pipe is 304 L stainless steel. This expansion joint is rated for 145 psi with 1" compression and temperatures up to 600°F. The unit was 100% x-ray tested, hydro-tested and 100% dye-penetrant tested.



### 102" Diameter Tied Universal and Hinged Expansion Joints



U.S. Bellows designed and fabricated tied universal expansion joints and single hinged expansion joints for a power plant in Canada. All the units were fabricated from carbon steel with 316 stainless steel bellows. The universal tied joints are 102" diameter, 225" long and are designed for 8.2" lateral movement. The hinged joints are 102" diameter, 71" long and designed for 0.76° angular rotation. Each expansion joint can withstand temperatures up to 250°F at 7.25 PSIG.

The bellows and pipe long seams were 100% x-rayed, and all the welds were 100% dye-penetrant tested. A soap and air test was performed prior to shipment.

### 66" Hinged Expansion Joint Designed for Gas Service

This single hinged expansion joint is designed for sulphur dioxide service in a sulphuric acid plant. It was fabricated with 321 stainless steel bellows and liner, and A-516 GR 70 carbon steel hinge plates and pipe. The pipe is 66" outside diameter and 35-1/4" overall length. The expansion joint was designed for 6° angular and 3 PSIG at 680°F. The bellows and pipe long seams were 100% x-rayed, and all the welds were 100% dye-penetrant tested. A soap and air test at 15 PSIG was conducted prior to shipment.



### 24" Universal Hinged Expansion Joint



This universal hinged expansion joint includes elbows on both ends for an overall length of 125 5/8". It is designed with Inconel® 625 bellows, a 304 stainless steel liner, and carbon steel 150 lb. flanges. The hinges allow for up to 5 degrees of angular movement. The longitudinal weld seams were 100% dye-penetrant examined prior to being formed. The expansion joint was hydro-tested at 188 PSIG.

The longitudinal weld seams were 100% dye-penetrant examined prior to being formed. The expansion joint was hydro-tested at 188 PSIG.

## PRODUCT SHOWCASE

### Hinged and Universal Expansion Joints with Refractory Lining



U.S. Bellows, Inc. designed and fabricated refractory lined single-hinged and universal expansion joints for a design pressure of 75.4 PSIG and 1400°F temperature. Each expansion joint was 100% x-ray tested along the weld seams and pneumatically tested to 83 PSIG.

### 48" Diameter Refractory Lined Expansion Joint for a Chemical Plant in Ecuador

This refractory lined expansion joint was designed with pantographic linkages for a chemical plant. It was designed for 60 PSIG and 1450°F with a 4" thick refractory installed per UOP specifications. The bellows was constructed from SB-443 Inconel® 625, and the weld ends, hinges, pantographic linkages, and floating ring were made from A516-70. The bellows, weld ends, and spool long seam welds were 100% x-rayed and 100% dye-penetrant tested per ASME standards. A pneumatic test was performed at 15 PSIG for the entire expansion joint assembly prior to shipping.



### 92" Double Hinged Reinforced Expansion Joint for Water Service in Canada



U.S. Bellows, Inc. designed a double hinged reinforced expansion joint for a 92" diameter pipe in a water treatment plant located in Canada. The bellows, root rings and collars are fabricated from 321 stainless steel. The weld ends and hinge hardware are fabricated from carbon steel. This expansion joint was designed for 100 PSIG at 300°F with 4° angular movement for each bellows. The bellows long seams and longitudinal pipe welds were 100% x-ray examined, hydro-tested at 150 PSIG, along with a 100% dye-penetrant test for all welds was performed prior to shipment.

### 24" Inline Pressure Balanced Expansion Joint

U.S. Bellows, Inc. fabricated three, 24", inline pressure balanced expansion joints for a petrochemical plant in Venezuela. In order to absorb partial axial and lateral movements, these expansion joints were designed at 175 PSIG and 610°F. The bellows are composed of Inconel® 625LCF material and the flanges and liners are constructed from SA516 Grade 70 material.





## PRODUCT SHOWCASE



### 26" Diameter Pressure Balanced Elbow Expansion Joint

This 26" diameter pressure balanced elbow expansion joint was received for a complete refurbishment. New SA-240 type 321 stainless steel bellows were used to replace the original bellows, and the tie rods and flow liners were also replaced. All carbon steel parts were painted with a universal primer. This expansion joint measures over 17 feet long center to center of elbows, and is currently being used in an effluent header at Cedar Bayou plant.

### 60" Diameter Universal Pressure Balanced Elbow Expansion Joints

The universal pressure balanced elbow expansion joints were fabricated with 304 stainless steel bellows and carbon steel reinforcing root rings. The expansion joints were designed for an axial compression of .25", extension of .75", and lateral of 1". They have an overall length of 237" from center line or elbow to face of the weld end. All expansion joints were designed for 100 PSIG and hydro-tested at 150 PSIG.



### 8" Diameter Pressure Balanced Expansion Joint

This 770 lb. pressure balanced expansion joint was designed for a company in Ohio. The expansion joint, designed for 450 PSIG and 1350°F, will be used for wind tunnel testing of airplanes and engines. With an overall length of 70", it consists of four 8" diameter bellows with 3 plies of Inconel® 625 Gr1 material, an 8" diameter Inconel® 800 HT elbow, four 7/4 A193 B8 tie rods, and four 2" thick A240 tp304H rings. To ensure quality, 100% x-ray and 100% dye-penetrant tests were performed on the bellows. A pneumatic test at 550 PSIG was conducted on the entire assembly prior to shipping.



### Elbow Pressure Balanced Expansion Joints for a Power Station in Canada

These joints are designed at 150 PSIG and 450°F to allow lateral and axial movements in a 42" steam line. The expansion joints were designed and fabricated per EJMA and B31.1 code. The expansion joints were hydro-tested at 225 PSIG and 75°F. In order to detect any leaks in the weld, prior to and following forming, bellows long seam welds and attachment welds were 100% dye-penetrant tested. The expansion joints were shipped to a power station in Canada.



## PRODUCT SHOWCASE

### 72" Universal Pressure Balanced Expansion Joint

This 72" universal pressure balanced expansion joint was designed for a chemical plant in Pasadena, Texas. The expansion joint is designed for 30 PSIG at 200°F and full vacuum. All materials in the "wetted surface" are TP-316/316L stainless steel. Design movements are 3" axial compression and 5 3/4" lateral offset. The assembly is approximately 24' long and 14,150 lb.



### 30" Spent Catalyst Standpipe Metallic Expansion Joint with Pantographic Linkage

This 30" spent standpipe catalyst metallic expansion joint was fabricated for a refinery in Montana. The overall installed length of the expansion joint is 89". The design pressure was 19 PSIG and the design temperature was 1050°F. The expansion joint is fabricated entirely from 321 stainless steel, except for the carbon steel flanges to match the existing nozzle material and drilling. The assembly is lined with abrasion resistant refractory which prevents erosion of the 321 stainless steel piping. The pantographic linkage, shown in the photo, is designed to distribute the axial compression between the two bellows and support the weight of the center pipe between the bellows.

### 80" Refractory Lined Tied Universal Expansion Joint

This 36'-0" long refractory lined tied universal expansion joint weighs 54,000 lb. and has two-ply Inconel® 625 LCF bellows, tie rods, slotted hinges, insulation bags and liner seals. It is designed to operate at 58 PSIG and temperatures up to 1,450°F. The expansion joint was preset for 6" lateral travel and is capable of lateral travel up to 13".



### 60" Diameter Tied Refractory Lined Universal Expansion Joints



These refractory lined universal expansion joints were fabricated for a carbon monoxide ducting system at a chemical refinery. The expansion joints are lined with a 3/4" thick abrasion resistant refractory lining with hexagonal mesh reinforced anchor. A240 TP 304 material was used to fabricate the bellows and flanges and A240 TP 310 material was used for the spool. Designed for 2 PSIG, the joints were air tested at 5 PSIG to ensure quality performance. A dye-penetrant test was also implemented on

the bellows' long seam and attachment welds. These expansion joints were fabricated and designed per B31.3 and EJMA standards.

## PRODUCT SHOWCASE

### 60" Diameter Double Hinged Refractory Lined Expansion Joint

This expansion joint with an overall length of 40'-0" has a 4" thick refractory lining installed per UOP specifications. It consists of testable two plies SB-443/Inconel® 625LCF bellows, 5/8" thick, A516-70 mitered elbows, 5/8" thick, A516-70 spool, A240-304 liners, A516-70 hinges, A193, GR 7 tie rods, and A516-70 lugs. It was designed for 50 PSIG and 1440°F with 3" of lateral movement per B31.3 and EJMA standards. A 100% x-ray, 100% dye-penetration tests and a pneumatic test at 75 PSIG were conducted on the expansion joint assembly prior to shipping.



### 55" O.D. Refractory Lined Universal Gimbal Expansion Joint



Two 55" O.D. refractory lined universal gimbal expansion joints were custom designed for a refinery in Joliet. They are equipped with slotted hinges with an overall length of 163" and 286" respectively. The 163" O.A.L. expansion joint, designed for 60 PSIG and 1020°F, will be used at the reactor stand pipe of the refinery. The 286" O.A.L. expansion joint will be used for the regenerator stand pipe of the refinery and it is designed for 57 PSIG and 1300°F. Both expansion joints consist of a A516 Gr70 pipe, two SB-443 two-ply bellows and a slotted hinge.

### 44" Universal Refractory Lined Expansion Joint

U.S. Bellows, Inc. specially designed and fabricated a 44-inch, O.D Universal, refractory lined expansion joint for a chemical plant in Venezuela. The expansion joint was designed for 100 PSIG at 1,000°F and fabricated with 321 SS two-ply tested bellows, A-387 GR11 weld ends, 14 Ga. 304 SS, Hexmesh anchoring system and Resco 17 EMC refractory.



### Universal Expansion Joint with 5" Thick Refractory Lining for a Styrene Plant in Thailand



This universal expansion joint is designed with 5" thick refractory lining for a 52" pipe in a styrene plant in Thailand. It measures 154" long and is fabricated with ASTM A 304H stainless steel pipe ends and Incoloy 800H bellows. The expansion joint is designed for a lateral movement of 6.982" with a design pressure of 30 PSIG at 1085°F. The bellows and pipe longitudinal seams and the pipe circumferential welds were x-rayed. A pneumatic test between the plies at 15 PSIG and the complete expansion joint at 45 PSIG was performed. The carbon steel surfaces were coated with a special three-coat paint system after testing and prior to shipment.



## PRODUCT SHOWCASE



### **Stainless Steel Expansion Joint for Catalytic Cracker Application**

The expansion joint that is being prepared for shipping at night is a stainless steel, universal expansion joint. This unit was refractory lined before being shipped to a refinery for installation in their piping system for a catalytic cracker application.

### **92" I.D. Toroidal Bellow Expansion Joint for an ASME "U" Stamp Heat Exchanger Shell**

The toroidal shape gives the bellow the unique ability to carry high pressures; conversely, it also permits modest deflection ability. The expansion joint was designed for 400 PSIG at 500°F and an extension stroke of 5/16 and the bellow's element was fabricated from .060 Inconel® 600 with A-516 gr 70 weld ends.

The 92" toroidal expansion joint was also designed per ASME

Sec. VIII rules as well as the Expansion Joint Manufacturer EJMA Standards. Upon fabrication completion, hydrotest was conducted at 600 PSIG to detect leaks.



### **48" Diameter Thick-Wall Expansion Joint for a Refinery**

This 48" diameter thick-wall expansion joint was fabricated for a refinery in Louisiana. The joint was fabricated from carbon steel with a 1/8" minimum thickness. It is designed for an axial force of 2,500 lb./in. with a 1.15" axial deflection and a lateral force of 30,000 lb./in. with a 0.002" lateral deflection.

### **5' x 22' Thick-Wall Tied Universal Expansion Joint**

This 5' x 22' stainless steel, thick-wall, tied, universal expansion joint was designed and manufactured for a major producer of agricultural chemicals in Louisiana. A special in-house CAD program was utilized in the design effort for these expansion bellows to meet the process parameters. Also, special guides and anchors were provided to facilitate proper operation of this critical unit within the system.



## PRODUCT SHOWCASE



### 72" Diameter Thick-Wall Expansion Joint

The 72" diameter thick-wall expansion joint pictured at left is for SO<sub>2</sub> service. It has 8 3/16" thick, 10 1/2" high 304H bellows to allow 4" of axial compression and 2 1/2" of lateral deflection. These thick-wall joints are designed with indefinite cycle life.

### 12' Diameter Thick-Wall Duct Expansion Joint

A twelve foot diameter 304 stainless steel thick-wall duct expansion joint produced by Piping Technology & Products, Inc. is shown supported and braced ready for shipment. Special equipment had rolled the knuckles from 1/4" material which is then circumferentially welded. This results in an expansion joint with the minimum stresses possibly exerted and, at the high point of the convolution, its most vulnerable area.



### Thick-Wall Expansion Joints for Texas Refinery

The three pictures at left show thick-wall expansion joints being installed in a Texas refinery. Workers are covering the expansion joints with insulation, then covering the insulation with aluminum. The 72" expansion joints, which are fabricated from 1/4" carbon steel plate, have a 10" convolution.

### Thick-Wall Expansion Joint

The photograph at right shows thick-wall expansion joints. Thick-wall joints are cost effective for large diameter piping systems which operate at low pressures. Metals can be selected to satisfy different temperature conditions and combinations of axial, angular and lateral forces.





## PRODUCT SHOWCASE

### 72" Diameter Tied Universal Expansion Joint for a Sulfuric Acid Plant

This 30' long tied universal thick-wall expansion joint is fabricated from carbon steel with 316 stainless steel bellows. The bellows are fabricated from 1/4" thick flanged and flued heads. It is designed for an axial movement rate of 1/2" with a lateral movement rate of 1-13/16". The expansion joint was 100% x-ray tested and air and soap bubble tested prior to shipping.



### Rectangular Fabric Expansion Joint

The fabric expansion joints' frame and liner are fabricated from 304 stainless steel. The three layer fabric belt consists of an inner layer of silica cloth, a middle layer of mineral wool and an outer layer of PTFE/ coated fiberglass. Dye-penetrant examination was performed on all welds of the expansion joint's frame prior to shipping.

### 36" x 10" Face-to-Face Fabric Expansion Joints

This 36" diameter fabric expansion joint with a three layer fabric belt includes 150 lb. flat face flanges with carbon steel backing bars and liner. The fabric belt consists of silical fabric, fiberglass fabric and mineral wool insulation.



### 60" Ductwork and a Fabric Expansion Joint



This fabric expansion joint is furnished with acid resisting fabric and also a duct work measuring 34' long and 60" in diameter which was fabricated from ASTM A 516GR 70 carbon steel. The expansion joint was completed within 6 weeks in time for a plant shutdown. A computerized pipe stress analysis, utilizing the Caesar II stress program, was performed to obtain the forces and moments imposed on the equipment nozzles and weights to be carried by the spring supports.

## PRODUCT SHOWCASE

### 3 Fabric Expansion Joints for a Power Company in Texas

These fabric expansion joints are made of stainless steel liner, flanged ends, backing bars, and Nomex® fabric cloth. They weigh between 370 lb. – 380 lb. and measure 81.15" long, 18.44" wide, and 16" high. They are used in high temperature air ducts to allow for expansion. Its thermal growth consists of +/- 1/8 X-Y-Z directions. It is capable of withstanding 400°F at +/- 0.8 PSIG at a maximum flow of 130,650 ACFM. Standard testing was performed for quality assurance.



### 17 Fabric Expansion Joints for a Gas Turbine Power Plant

These rectangular fabric expansion joints measure 136" x 54" with a weight of 135 lb. each. They were fabricated out of fiberglass fabric with stainless steel frames and are designed for ± 5 PSIG and 400°F. The expansion joints were manufactured according to specific customer specifications.

### 48 Multi-Layer High Temperature Rectangular Fabric Expansion Joints

The rectangular fabric expansion joints consisted of two carbon and stainless steel frames separated by a high temperature silica fabric. The frames measured 13" x 37" x 6", 14½" x 20½" x 6" and 17¼" x 17¼" x 4" and weighed 90, 115, and 170 lb. Each expansion joint was designed for a 15" Water Column (W.C.) with a temperature of 750°F and allowed for movement ranging from ±½" to ±1" both axially and laterally.



### 54" x 136" Fabric Expansion Joints for a Power System Company in Texas



These 17 rectangular fabric expansion joints were custom designed for a power system company in Texas. The expansion joints measure 54" x 136" and weigh 135 lb. each. They are designed for operation up to 5 PSIG and temperatures up to 400°F. The expansion joints are made of fiberglass fabric and have stainless steel frames.

## PRODUCT SHOWCASE

### Fabric Expansion Joints for a Power System Company in Texas



The expansion joints range in size from 30" to 62" in diameter and the rectangular expansion joints measure 81" x 18" and 136" x 54". They are designed to operate from 0.8 to 5 PSIG and in temperatures ranging from -40°F to 400°F. The products were fabricated using neoprene and fiberglass fabric with carbon and stainless steel frames. A special paint system was applied per customer's request.

### 78" x 39" Rectangular Fabric Expansion Joint

This 315 lb. 78" x 39" multi-layer fabric expansion joint was designed for a power company in Texas. This fabric expansion joint will be mounted inside a turbine enclosure and allows for a 15,000 cfm air flow through the enclosure. It is designed for 27 1/2" W.C. and 930°F with 0.27" axial and  $\pm 0.12$ " lateral movements. The expansion joint is equipped with a stainless steel frame and a 6" thick insulated pillow which is enclosed in a stainless steel woven wire mesh.

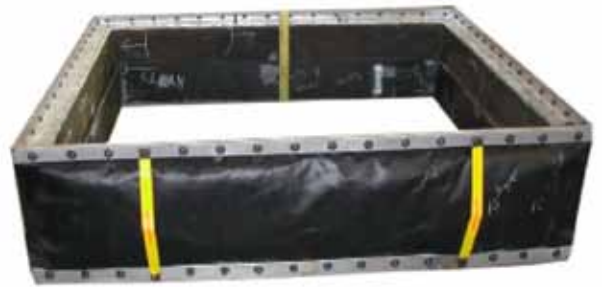

### 5" x 12" Fabric Expansion Joint

This 5" x 12" fabric expansion joint was designed and manufactured for a hot air ducting system in a power plant in Tulsa, OK. It is designed at 15" W.C. and 600°F for 3/4" axial movement and 1/2" lateral movement. The fabric belts are composed of three layers with the outer layer serving as a water-proof barrier.

### Rectangular Fabric Expansion Joint for Coal Fired Power Plant

This 21' x 14' expansion joint was designed at 1 PSIG and 1200°F for an air duct at the power plant. The frame is all A-240 and 304 stainless steel construction. This expansion joint is equipped with 6" thick insulation pillows. Telescoping liners hold the insulation pillows between the liner and the fabric belt to reduce heat transfer and prevent ash accumulation.





## PRODUCT SHOWCASE



### 87 Fabric Expansion Joints for a Furnace Application

U.S. Bellows, Inc. manufactured 87 rectangular fabric expansion joints for a furnace application at a chemical plant in Texas. The joints were designed at 11" W.C. and 750°F for ½" axial and lateral movements. The fabric belts on these joints are composed of three layers. They were equipped with a telescoping liner and 2" thick insulation pillows to reduce the heat transfer.

### Fabric Expansion Joints Up to 32' x 12'

These expansion joints reach sizes up to 32' x 12' for a power station in New York. The largest of the expansion joints that are to support the air ducts of the power station, was designed at 32' x 12', while the others measured at 10' x 12'. The expansion joints were fabricated with high temperature fabric belts and 4" thick insulation pillows. The designing conditions were at 30" W.C. and 950°F.



### 12' x 30' x 12" High Temperature Fabric Expansion Joint



This expansion joint was fabricated with a 3-layered fabric belt, A516 Gr. 70 telescoping liners/frame and insulation pillows. It was designed at 650°F and 30" W.C. for 1/2" compression and 1/4" lateral. This expansion joint will be installed in an exhaust system at a power plant in New York. EJMA standards, Fluid Sealing Association standards and B31.3 code were

used in the design and fabrication of these joints.

### Fabric Expansion Joint for Duct System

The photograph at right shows a fabric expansion joint designed and built for installation in a duct system. These joints can be fabricated from a variety of metals in a variety of shapes depending on the particular application. They are used where ducts carry hot gases at low pressures. The fabric "belt" is a combination of layers of different materials selected to withstand the high temperatures.



## PRODUCT SHOWCASE

### Replacement Fabric Expansion Joint for a Methanol Plant

The photograph at right shows rectangular expansion joints being prepared for shipment to Russia. These were fabricated to replace units in a methanol plant duct system. The fabric belt is constructed of layers of material selected to handle the hot gases at low pressures. The frames can be fabricated from a variety of metals in a variety of shapes depending on the particular application.



### High-Temp Fabric Expansion Joints

This high-temperature fabric expansion joint was designed and manufactured by U.S. Bellows, Inc. The fabric “belt” is attached between two short sections of pipe. These expansion joints are inserted in metal pipes which carry hot gases at low pressures. Layers of different materials are selected to make a belt which will function at the high temperatures required.

### Neoprene Fabric Expansion Joints for a Ventilation Fan Intake Duct

Neoprene fabric expansion joints were custom designed for a ventilation fan intake duct in a power plant. They are 42" in diameter and are 65" in overall length. They were designed for 1/4" axial movement, 1/8" lateral deflection and a 100" W.C. at 200°F. The expansion joints are fabricated with a neoprene reinforced belt with stainless steel clamps, carbon steel spool pipe and angle flange ends. Each joint was dye-penetrant examined prior to shipping.



### Fabric Expansion Joints Designed for a Lignite Coal Processing & Gasification Plant



A total of thirty-six fabric expansion joints were custom designed for a lignite coal processing and gasification plant in Mississippi. They are 12" diameter, 14" overall length and designed for 1/4" axial movement and .8" lateral movement. The expansion joints are fabricated with carbon steel flange ends, stainless steel clamps and a PTFE coated fabric belt. They are designed for hot air circulation flow at 600°F and a pressure of 30" W.C.



## PRODUCT SHOWCASE

### 81" Long Rectangular Fabric Expansion Joint for an Offshore Oil Extraction and Natural Gas Project

A total of three rectangular fabric expansion joints and six round fabric expansion joints were custom designed for an offshore oil extraction and natural gas project. The rectangular joints are 56" x 81" I.D. x 25" O.A.L. and the round joints are 105" diameter x 24" O.A.L. 309 stainless steel was used for the duct, 310 for the liners, 316 for the covers, 321 for the studs, 309 for the flanges. The fabric belt was a three layer belt with an inner layer of glass cloth, a layer of KO wool and an outside layer of reinforced PTFE. The expansion joints were designed for 1 PSIG at a temperature of 1100°F. The rectangular joints were designed for 2" axial compression, a 1" extension, and a 1" lateral offset. The round joints were designed for 4" axial compression, a 1" extension, and a 0.5" lateral offset. All welds were dye-penetrant examined.



### Rectangular Fabric Expansion Joint For High Air Circulation Flow

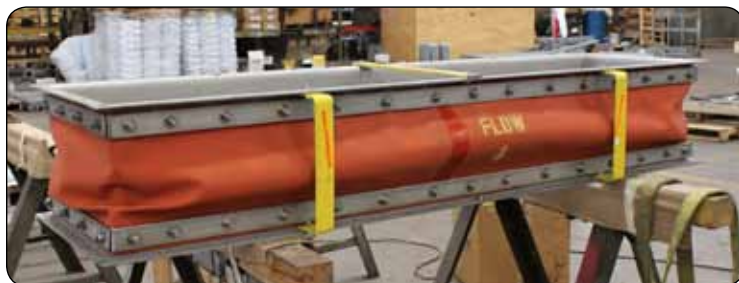

This rectangular fabric expansion joint is designed for high air circulation flow for an air cooling loop duct in a power plant. It measures 81" L x 18" W x 16" face-to-face, and is fabricated with stainless steel angle, frame ends and internal liner. The fabric belt material is reinforced silicone fabric cloth, which can withstand temperatures up to 550°F. This expansion

joint is rated for axial movement of +/- 1" with a 1/2" lateral offset. A dye-penetrant test on all welds was conducted prior to a quality assurance inspection prior to shipment.

### High Temperature Fabric Expansion Joint Designed for an Exhaust Duct

This rectangular fabric expansion joint will be used in an exhaust duct in a power plant. It measures 136" L x 54" W x 12" face-to-face and is fabricated with stainless steel angle, frame ends and internal liner. The fabric belt material is PTFE coated glass cloth, which is low friction and high in tear/crease resistance and tensile strength. This



expansion joint is rated for an axial movement of 1-1/2" with a lateral offset of 1/2" and maximum temperatures up to 600°F. A quality inspection was administered, including a dye-penetrant test prior to shipment.

## PRODUCT SHOWCASE



### **42" Diameter Neoprene Fabric Expansion Joint for a Generator Cooling Fan in a Power Plant**

This neoprene fabric expansion joint is 42" I.D. by 7-3/4" face-to-face and is designed for a generator cooling fan in a power plant. The angle frame ends are fabricated from carbon steel, and the neoprene fabric belt is fastened to the angle flanges by two stainless steel clamps. The expansion joint absorbs vibration

between the air supply duct and the cooling fan. A dye-penetrant exam was performed on the welds of the angle iron flanges prior to shipping to the customer ahead of schedule.

### **78" Fabric Expansion Joint and Duct Work Assembly with a 90° Elbow for a Sulphuric Acid Plant**

U.S. Bellows designed and fabricated a 78" fabric expansion joint and duct work assembly with a 90° elbow for a sulphuric acid plant in Louisiana. A stress analysis was performed to determine thermal movements and spring supports, loads and travel. The ducts are fabricated from carbon steel and are 30' long. The expansion joint is designed for 750°F at 5 PSIG with 2.5" lateral deflection (cold preset) and 2" axial compression. Cradle supports and a "big ton" spring support were also fabricated for this project.



### **Fabric Expansion Joint Designed for a Power Generator Unit**



This fabric expansion joint is 13' long by 5' wide and 21" deep. The frame and liner are fabricated from 304 stainless steel and the belt is a fiber glass reinforced PTFE material. Prior to shipping for installation in a power generator unit, all the welds were dye-penetrant examined.

### **10' Square Fabric Expansion Joints**

The fabric expansion joints are fabricated from a high temperature and corrosion resistant composite belt with A588A Corten steel duct, flanges, and covers. They are 10' square and 24" face-to-face. All welds were 100% dye-penetrant, soap and air tested prior to shipping. The expansion joints will be used for a flue gas application in an oil refinery in Texas.



## PRODUCT SHOWCASE



### Air Duct Fabric Expansion Joint

This air duct fabric expansion joint has a unique design that allows for lateral movement of 2" in any direction. It will be used in an air duct system as a transition piece between the air blower and the air duct. This expansion joint is fabricated with Alpha 827 fabric cloth and A36 carbon steel flanges and has a design temperature of 300°F at .1 PSIG. The

top flange measures 68-5/8" L x 57-5/8" W and the bottom flange measures 53-5/8" L x 64-5/8" W.

### 44" Expansion Joints for a Petrochemical Plant

U.S. Bellows, Inc., a division of Piping Technology & Products, Inc., designed and fabricated 44" fabric expansion joints for a petrochemical plant in Malaysia. The expansion joints measure 44" ID x 40" face-to-face and are fabricated from stainless steel pipe and flanges and a three layer fabric belt protected by an insulation pillow. The design conditions were 3 PSIG at 845°F. The expansion joints are designed for a lateral movement of 1/2" and an angular rotation of 1.5°. Stainless steel covers were included to protect the fabric expansion element from possible outside damage.



### 128" x 229" Rectangular Fabric Expansion Joints



The fabric expansion joints shown at left are fabricated with a three layer fabric belt. The three layers consist of an inner layer of silica cloth, a middle layer of mineral wool and an outer layer of PTFE/coated fiber glass. The frame includes an insulation blanket of mineral wool and stainless steel wire mesh. The frame and liner are fabricated from 3/8"

thick 304 stainless steel and each expansion joint's frame and liner welds were dye-penetrant tested before shipping.



## PRODUCT SHOWCASE

### Two Fabric Expansion Joints for an Oil Refinery in Saudi Arabia

These are 24" diameter fabric expansion joints with an overall face-to-face dimension of 12". Each expansion joint weighs 300 lb. Installed in the inlet and exhaust piping of a hot air blower; they can withstand temperatures of up to 850°F. These expansion joints were fabricated in three layers that consisted of aluminized fiberglass, ceramic fiber, and silica treated fabrics. The flanges were fabricated from carbon steel with special hex nuts welded to the inside of the bolt holes. The stud bolts are in place to assure correct alignment of the bolts to the flange bolt holes.

Visual inspection and trial fitting of the stud bolts were performed to assure quality and performance.



### 84" Long Rectangular Metallic Expansion Joint



This rectangular metallic expansion joint measures 22" x 84" x 11" face-to-face and is fabricated from 316 stainless steel bellows and carbon steel flanges. This expansion joint is designed to absorb axial compression in a hot air duct system to a fan inlet. The bellows have three convolutions with mitered corners. The expansion joint was 100% dye-penetrant, soap and air tested prior to being shipped to a power plant.

### Tandem Rectangular Expansion Joint for Turbine Exhaust

The expansion joint weighs more than 1,700 lb. and is capable of +/- 1/4" axial movement and +/- 1/8" lateral movement. It is designed to operate under designed pressures ranging from full vacuum to 15 PSIG at 250 degrees. The bellows and liner of the expansion joint are made of 304 stainless steel with a carbon steel flange and duct. To insure quality, the product was 100% dye-penetrant tested prior to shipping.



### 55' Long by 14'6" Rectangular Metal Expansion Joint

U.S. Bellows, Inc. fabricated two metallic expansion joints on an expedited schedule. The expansion joints were fabricated from COR-TEN ASTM 588 carbon steel and are designed for 1.2 PSI at temperatures up to 748°F. The expansion joints were designed for an axial compression of 1.5" and a lateral resultant movement of 1.84". The entire expansion joint was shipped to the job site in one piece.

This avoided having to splice weld the expansion joint into one piece, which saved the customer countless assembly man hours in the field.



## PRODUCT SHOWCASE

### 57" x 96" Rectangular Seal Expansion Joints

Designed at 2 PSIG for 1350°F, the seal joints provide for one inch of axial movement to prevent damage to flange connections. EJMA Standards and B31.3 code were used in the design and fabrication of these joints. The purpose of the rectangular seal expansion joint is to prevent leakage to outside of the burney windbox. The corners are double mitered to reduce stress. Inconel® 625LCF material was used in fabricating the bellows while A240 tp 310 material was used for the frame. An air test at 5 PSIG was implemented as well as dye-penetrant testing on the bellows.



### Three 12' x 8' Rectangular Expansion Joints with Full Radius Corners

These rectangular expansion joints were designed at 5 PSIG and 650°F. They are fabricated with full radius corners which allow for an increased cycle life. The bellows are formed from Inconel® 625 SB-443 GR. 1 and the rest of the assembly is fabricated from A516-70. The long seam welds were 100% x-rayed. A 100% dye-penetrant test was performed on the attachment welds.

### 28"x 66" Rectangular Expansion Joint

This stainless steel rectangular expansion joint, 28" x 66", was manufactured for an exhaust system at a chemical plant in South Carolina. This joint is equipped with a liner, tie rods system and mitered corner bellows design. The expansion joint was designed for 15 PSIG at 600°F and leak tested. A 100% dye-penetrant test was also performed on all the welds.



### 48" Tied Universal Expansion Joint with Two-ply Bellows

This tied universal expansion joint will be installed in an oil refinery in Louisiana. The assembly is 48" in diameter and 150" long. The bellows are fabricated from two plies of Inconel® 625 LCF with stainless steel mesh between the plies and the weld ends and all hardware are A 516 GR 70 carbon steel. The design temperature is 500°F at 38 PSIG with 5" lateral movement. The bellows were 100% x-rayed and hydro-tested to 76 PSIG. A pneumatic test between the plies at 15 PSIG was performed prior to shipping.

## PRODUCT SHOWCASE

### Tied Universal Expansion Joint with a 45 Degree Mitered Elbow



This tied universal expansion joint with a 45 degree mitered elbow will be installed in a flue gas system. The assembly is 60" in diameter and 215" long. The pipe is fabricated from A 516 GR 70 carbon steel and the bellows are Inconel® 625 LCF. The bellows were 100% x-rayed and hydro-tested to 15 PSIG prior to shipping.

### 66" Diameter Tied Universal Expansion Joint

This tied universal expansion joint is designed to carry hot gas up to temperatures of 1022°F and pressure up to 5 PSIG. It has a 66" inside diameter and is 126" in overall length. The design movements are 3" lateral and 4.5" axial compression. The bellows material is Inconel® 825 with 316 L SS flow liners, carbon steel weld ends and limit rods. The bellows and pipe longitudinal weld seams were 100% water clear x-rayed and dye-penetrant tested prior to a 5 PSIG air test. All exterior surface of carbon steel pipes are high heat aluminum painted.



### 15' Tied Universal Expansion Joint with Slotted Hinges



This tied universal expansion joint is 18" in diameter and 15' in overall length. The expansion joint is fabricated with an Inconel® 800 bellows, 316H stainless steel pipe and 304H stainless steel tie rods and slotted hinges. The design pressure is 65 PSIG at 1076°F. A hydro-test at 127 PSIG was performed as well as

dye-penetrant testing to ensure product quality.

### Metallic Universal Expansion Joint for an Emergency Shut Down

One of U.S. Bellows' customer's existing expansion joints failed and caused a plant shut down. They required an immediate replacement joint. This universal expansion joint order was placed, designed and fabricated in just one day. The order came in at 8:30 am on Saturday, Labor Day weekend and was shipped at 4:00 pm, which minimized the time of the plant shut down. This universal expansion joint is 96" in overall length, 20" inside diameter and can absorb 3.25" lateral movement. A 100% dye-penetration test and a hydro-test were performed to ensure quality.



## PRODUCT SHOWCASE

### Expansion Joints for an Engineering and Construction Company



These expansion joints weigh 1,600 lb. each and are 10" in diameter. They are designed for 611 PSIG and temperatures up to 180°F. These expansion joints are fabricated from 321 carbon steel pipe, tie rods and 300 lb. RF weld neck flanges. The bellows weld seams were 100% x-rayed and the complete assembly was hydro-tested to 917 PSIG to ensure a quality product and performance. The units were shipped with the mating flanges bolted to the end of the assembly.

### 5,165 lb. Tied Universal Expansion Joint

This 60" diameter and 120" long universal expansion joint was custom designed for a chemical plant in Louisiana. It was fabricated from 304 stainless steel bellows and carbon steel. It was designed for 10 PSIG and 550°F. To ensure quality a 100% dye-penetrant, radiography and soap leak test was performed prior to shipment.



### 48" Diameter Tied Universal Expansion Joints

Five tied universal expansion joints ranging in size from 30" to 48" were designed and manufactured for an oil and gas company in France. These expansion joints weigh between 2400 lb. and 3200 lb. and are fabricated from 304-321 SS bellows. They are designed for pressures ranging from 55 to 650 PSIG and 148°F to 300°F operating temperatures. To ensure quality, the joints were 100% x-rayed, 100% dye-penetrant, and hydro-tested at 83 to 975 PSIG.

### 3,212 lb. Tied Universal Joint for an Oil Piping System

This 5" nominal diameter and 60" long universal expansion joint was designed for an oil piping system application in Nevada. The assembly consists of high strength Inconel® 625LCF bellows and A105 flanges. It is designed for 1400 PSIG and 120°F per B 31.3 and the latest revision of EJMA standards. It is also designed to allow 4 1/2" of lateral movement during operation. A 100% dye-penetrant and hydro-test at 2100 PSIG were performed prior to shipment.





## PRODUCT SHOWCASE

### 6" Diameter Tied Universal Expansion Joints

These eight 6" diameter tied universal expansion joints with 24" F-F were manufactured for a steam reformer project in Virginia. These expansion joints are made from two-ply Inconel® 625 bellows, A312 TP 304 spool, and A105 flange. They are designed for FV/50 PSIG and 300°F with axial and lateral movements of +/- 0.25" and 0.70", respectively. The joints were 100% x-rayed, 100% dye-penetrant, and hydro-tested at 75 PSIG. Flanges, tie rod, and spherical nuts are hot dip galvanized per customer specification.



### Three 23'-1/3" Expansion Joints for a Refinery in New Jersey

Three 2'-6" OD x 23'-1/3" long expansion joints were designed and manufactured for a refinery in New Jersey. The bellows, pipes, and lugs were fabricated from Inconel® 800H high nickel alloy, A312tp 316H stainless steel, and A240tp 316H stainless steel respectively. The expansion joints are designed for 60 PSIG, 1100°F, and 47,000 lb. of thrust to accommodate for a high temperature application.

### Expansion Joint Exhaust Assembly for an Oil Refinery in Texas

U.S. Bellows, Inc. designed and fabricated this expansion joint exhaust assembly for an oil refinery in Texas. This expansion joint is offset for an offshore platform and weighs approximately 8,000 lb. It has a design pressure and temperature of 1 PSIG and 1000°, respectively. An air test was conducted to detect any leaks.



### Tied Universal Expansion Joints for a Chemical Plant

These expansion joints were designed at 170 PSIG and 450°F to absorb lateral movements and tested per B31.3. They were made with Inconel® 625LCF bellows and A105 300 lb. RFSO flanges. The entire assembly was hydro-tested at 255 PSIG and held under pressure for four hours. In order to detect any leaks, each expansion joint and its welds were subjected to the dye-penetrant test and the x-ray test, each of which were 100%, prior to and following forming.





## PRODUCT SHOWCASE

### 14" Diameter Tied Universal Expansion Joints

These 14" diameter tied universal expansion joints were designed and manufactured for a steam application at a power plant in Illinois. The expansion joints were designed at 350 PSIG, 780°F and constructed from Inconel® 625 bellows, A105 300# RFSO flanges, A106 GR. B spool, and SA193 B7 tie rods. The expansion joints were hydro-tested at 525 PSIG.



### 54" Diameter Tied Universal Expansion Joint

This 54" diameter tied universal expansion joint was designed and fabricated for the NASA Space Center. The expansion joint was designed at full vacuum and 450°F and constructed with 304 SS bellows, liner and A516 Gr. 70 spool, weld ends and carbon steel tie rods. The bellows' attachment welds were 100% dye-penetrant tested.

### 28" and 32" Tied Universal Expansion Joints

These 28" and 32" O.D. tied universal expansion joints were fabricated for an oil refinery in China. The expansion joints were fabricated from 321 SS bellows, A105, 150#, RFSO. EJMA Standards and B31.3 code were used in the design and fabrication of these joints.



### Elbow Tied Universal Expansion Joints

These 16" and 30" elbow tied universal expansion joints were manufactured for a power station in Florida. These expansion joints, which are used to transport hot steam, are designed at 150 PSIG and 350°F. The bellows material is fabricated from Inconel® 625 and elbows and spool from carbon steel.

## PRODUCT SHOWCASE



### 47 1/4" I.D. Universal Expansion Joint

This picture shows a 47.25" I.D. universal expansion joint with SB-443 (Inconel® 625) round corners bellows and SA516-70 flanges for an ethylene plant in Saudi Arabia.

### 3" NPS Tied Universal Bellows For A Power Plant

Ninety-six 3" NPS tied universal bellows were manufactured for a power plant located in Saudi Arabia. The bellows' element is a unique design containing integral equalizing rings between the corrugations that provide excellent pressure resistance, as well as anti-squirm resistance. The tear drop shape of the rings add little resistance to movement and cycle life is not compromised. Pressure design is based on 252 psi at 689°F with a lateral movement of 1.0".



### Universal Tied Expansion Joint, 48" Diameter and 141" OAL for Service in an Acid Regeneration Plant



A tied universal expansion joint was custom designed for service in an acid regeneration plant in Louisiana. It is 48" in diameter, 141" in overall length and designed for 1" axial movement, 2-1/2" lateral movement and .33° angular rotation. The expansion joint is fabricated with 310 stainless steel bellows, and 301 SS liner, duct, flanges, transition duct and covers. It was designed for 10 PSIG at 1150°F, and was dye-penetrant examined, hydro-tested at 15 PSIG, and the bellows and pipe longitudinal weld seams were 100% x-rayed.

### 42" Diameter Stainless Steel Expansion Joints for an Offshore Application

These universal metallic expansion joints were custom designed for an offshore application. They are 42" diameter, 24" overall length and designed for 2" axial movement and 1-1/2" lateral movement. The expansion joints are fabricated entirely from 316 L stainless steel and designed for 1,000°F and 1 PSIG. Each unit was 100% dye-penetrant examined and soap and air tested prior to shipment.



## PRODUCT SHOWCASE



### 12" Diameter Universal Expansion Joints with Stainless Steel Bellows

These universal metallic expansion joints were custom designed for a chemical plant in Texas. They are fabricated entirely from stainless steel with 304 stainless steel bellows. The expansion joints are 12" diameter, 77-1/2" long and designed for 4-1/2" axial movement and 2" lateral movement. They were designed for 200°F and 100 PSIG. Each unit was 100% dye-penetrant examined and hydro-tested prior to shipment.

### Tied Universal Expansion Joints Designed for a Power Generation Plant in Texas

These tied universal expansion joints were designed for piping in a power generation plant in Texas. They are 6" in diameter, 60" in length, and will be used in a hot air application. The pipe, lugs and weld ends are fabricated from carbon steel, and the bellows are 321 stainless steel. The expansion joints are designed for 100°F at 3 PSIG and are capable of 6" lateral movement. Each unit was 100% dye-penetrant tested and soap and air tested prior to shipment.



### 55" O.D. Universal Gimbal Expansion Joint with Floating Rings



This expansion joint was fabricated for a FCC overhead vapor line at a refinery. It has an overall length of 310" and is fabricated from A387 Gr 11 Cl2 spool and Inconel® 625 LCF bellows. It is designed for 50 PSIG and 1075°F with 13" of lateral movement. To ensure quality, 100% dye-penetration, 100% x-ray and pressure tests were performed on the bellows. Pneumatic tests were also conducted on the expansion joint and between bellows dry plies at

55 and 15 PSIG respectively prior to shipping.

### 192" Double Gimbal Expansion Joints

Two 192" double gimbal expansion joints were manufactured for a chemical refinery in Channelview, Texas. These expansion joints consist of A240-321 bellows, A160 Gr. pipe, A516-70 gimbal rings, A516-70 liners and A106 Gr B purge connection rings. The expansion joints were designed for 15 PSIG and 650 F per B 31.3 and EJMA Standards. They were also designed to allow 8 degrees of angular movement during operation. To ensure quality, the expansion joints were air tested at 22 PSIG prior to delivery.





## PRODUCT SHOWCASE

### 36" Expansion Joints for a Company in Singapore

Three expansion joints were fabricated for an E&C company in Singapore. The expansion joints manufactured included one 36" single hinged expansion joint, one 36" double hinged expansion joint and one 36" double gimbal expansion joint. These expansion joints will be used in a compressor application. Due to the critical applications of these expansion joints, they were tested per ASME Sect. VIII Div. 1 Appendix 26. The bellows together with the hinge assembly were hydro-tested. Additionally, a dry nitrogen test between the two plies was conducted to ensure that each of the two plies would withstand the design pressure.



### Specially Designed Expansion Joints with 13" of Movement

These externally pressurized expansion joints were designed for 13" movement. They are capable of withstanding temperatures of 1100°F. Externally pressurizing a bellows eliminates squirm as a limitation to the design and permits the safe acceptance of large amounts of axial thermal expansion.

### 56 Externally Pressurized Expansion Joints for a Cooling System

The externally pressurized expansion joints are 37.5" in diameter and 36" face-to-face. The bellows are 304 stainless steel, and the flange and ring are carbon steel. This expansion joint is rated for 232 PSIG with 5" axial compression and temperatures up to 189°F. All bellows longitudinal welds were 100% x-rayed, all carbon steel welds were dye-penetrant examined and each unit was hydro-tested to 348 PSIG. A total of 56 units were fabricated for a cooling system in a new university for women in the middle east.



### 59" Neoprene Expansion Joint

This neoprene expansion joint measures 59" x 7" and is designed to be used in an air exhaust system. The flanges are fabricated from painted carbon steel angle flanges. The neoprene is fastened to the carbon steel angle flanges by stainless steel clamp rings. The expansion joint absorbs the vibration between the duct work and blower exhaust flange.



## PRODUCT SHOWCASE

### Two Expansion Joints for an Air Intake on a Generator Unit

These 59" x 39.5" fabric expansion joints were fabricated using a 1/8" thick neoprene sheet. The joints were then bonded to the carbon steel angles and plates, and secured using stainless steel band clamps, with T-bolt latches. The carbon steel angles and plates were primed and finished at Piping Technology & Products' paint production facility. The expansion joints were designed to facilitate any vibration and movement during the generator units' normal operation.



### 42" I.D. Rubber Expansion Joints

The expansion joints consist of bellows formed by 1/8" thick neoprene sheet and A36 carbon steel flanges coated with a special finish per customer's request. These expansion joints are 42" x 7 3/4". A dye-penetrant test was performed on the welds prior to shipping to ensure quality. The turn around for this product was four days.

### EPDM Tied Expansion Joints for a Construction Company

Two EPDM tied expansion joints were designed and fabricated for a construction company in Texas. These expansion joints have an inside diameter of 29". They are composed of A516 carbon steel grade 70 with a six-rod control assembly, EPDM, and plate flange. They were hydro-tested to 217 psi. These joints were ordered on a one-week rush basis to replace an existing joint that was leaking.



### Double Arched PTFE-lined Rubber Expansion Joints for a Polysilicon Plant

These expansion joints have PTFE-lined rubber convolutions with Inconel® 625 liners and stainless steel covers. They measure 10" I.D. x 5-1/4" O.A.L. The expansion joints are designed for 46 PSIG and temperatures up to 210°F with 1/2" axial compression.

## NOTES

## NOTES

## TERMS OF SALE

**GUARANTEE:** We guarantee for one year from date of delivery our manufactured products to the extent that we will replace those having manufacturing defects when used for the purpose which we recommend. If goods are defective, the amount of damage is the price of the damaged goods only and no allowance will be made for labor or expense of repairing defective goods or damages resulting from the same. We guarantee the other manufacturers' products we sell to the extent of the guarantees of their respective makers.

**SELLER'S LIABILITY:** Seller will not be liable for any loss, damage, cost of repairs, incidental or consequential damages of any kind, whether based upon warranty, contract or negligence, arising in connection with the design, manufacture, sale, use or repair of the products or of the engineering designs supplied to the Buyer.

**AGREEMENTS:** All agreements are subject to strikes, accidents or other causes beyond our control.

**SHORTAGES:** Any shortages should be made at the time of delivery to the carrier. No claims will be allowed if not written and received within 10 days of receipt of materials.

**CLAIMS:** All materials sent out will be carefully examined, counted and packed. Claims for goods damaged or lost in transit should be made on the carrier, as our responsibility ceases and the title passes.

**SPECIAL ORDER:** Orders covering special or non-standard goods are not subject to cancellation except on such terms as we may specify on application.

**RETURNS:** We cannot accept return of any goods unless our permission has been obtained.

**MINIMUM INVOICE:** \$100.00 - Minimum Freight \$25.00

**TAXES:** The amount of sales, excise or other taxes, if any, applicable to the products covered by this order, shall be added to the purchase price and shall be paid by the Buyer unless Buyer provides Seller with an exemption certificate acceptable to the Taxing Authorities.

**TERMS:** Net 30 days from date of shipment with approval.

**FREIGHT ALLOWANCE:** All prices are F.O.B. point of shipment. All weights are approximate.

**PRICES & DESIGNS:** Prices and Designs are subject to change without notice and unless specifically stated on order, materials will be furnished of design in effect at the time the order is filled.



Two Round Fabric Expansion Joints





Pressure Test on a Round Fabric Expansion Joint



PTFE Fiberglass Reinforced Rectangular Expansion Joints



Rectangular Fabric Expansion Joint For High Air Circulation Flow



Fabric Assembly



Neoprene Expansion Joints



128" x 229" Rectangular Fabric Expansion Joints

**Metallic Expansion Joints**  
**Fabric Expansion Joints**

- Bolt in
- Weld-in

**Duct Work & Furnace Bags**  
**Stock Metallic Bellows**



Three-layer Rectangular Expansion Joint

**U.S. Bellows is a member of the Expansion Joint  
 Manufacturer's Association (EJMA).**

- Member Since 2002
- Expansion Joints Designed per EJMA Standards
- Representation on both the Technical and Management Committees



Three 81.15" L x 18.44" W x 16" High Fabric Expansion Joints for a Power Company



**Mailing Address:**  
**P.O. Box 34506**  
**Houston, TX 77234-4506**

**Local: +1-713-731-0030**  
**Fax: +1-713-731-8640**  
**Toll Free: 1-800-787-5914**

**Plant Location:**  
**3701 Holmes Road**  
**Houston, TX 77051-1545**

**E-Mail: [sales@usbellows.com](mailto:sales@usbellows.com)**  
**[www.usbellows.com](http://www.usbellows.com)**

**[www.usbellows.com/emergency](http://www.usbellows.com/emergency)**

- Available 24/7 for quick-turn or emergency situations
- Installation & Maintenance
- Field Survey & Inspection
- Problem Resolution & Repair